



BBG BETA BURNER GAS SERIES



WARNING

These instructions are intended for use only by experienced, qualified combustion start-up personnel. Adjustment of this equipment and its components by unqualified personnel can result in fire, explosion, severe personal injury, or even death.

TABLE OF CONTENTS

	<u>Subject</u>	<u>Page</u>
A.	General Information	2
B.	Receiving and Inspection	2
C.	Capacities	3
D.	Dimensions	4
E.	Installation	4
F.	Ignition.....	10
G.	Initial Set-Up.....	12
H.	Operation.....	14
I.	Maintenance.....	14
J.	Recommended Spare Parts.....	17

Attachments: IPG-9
ZMI Ionization Pilot

These instructions are intended to serve as guidelines covering the installation, operation, and maintenance of Hauck equipment. While every attempt has been made to ensure completeness, unforeseen or unspecified applications, details, and variations may preclude covering every possible contingency. **WARNING: TO PREVENT THE POSSIBILITY OF SERIOUS BODILY INJURY, DO NOT USE OR OPERATE ANY EQUIPMENT OR COMPONENT WITH ANY PARTS REMOVED OR ANY PARTS NOT APPROVED BY THE MANUFACTURER.** Should further information be required or desired or should particular problems arise which are not covered sufficiently for the purchaser's purpose, contact Hauck Mfg. Co.



WARNING

This equipment is potentially dangerous with the possibility of serious personal injury and property damage. Hauck Manufacturing Company recommends the use of flame supervisory equipment and fuel safety shutoff valves. Furthermore, Hauck urges rigid adherence to National Fire Protection Association (NFPA) standards and insurance underwriter's requirements. Operation and regular preventative maintenance of this equipment should be performed only by properly trained and qualified personnel. Annual review and upgrading of safety equipment is recommended.

A. GENERAL INFORMATION

The BBG burners are baffle type gas burners designed for low pressure air operation in a wide range of applications. Available with an alloy tile for ambient combustion air and application temperatures up to 1800°F (980°C), or a refractory tile for application temperatures up to 2800°F (1540°C). With a refractory tile, the 1000 and 2000 series can operate with air preheat temperatures up to 300°F (150°C), and the 3000 series can operate with air preheat temperatures up to 900°F (480°C).

The BBG burners fire any clean industrial fuel gas. Capacities range from 3.1 million to 123 million Btu/hr (820 to 32,530 kW). Higher capacity models are available upon request. Two refractory tile options are available: the diverging tile which produces a slow mixing, long, wide flame, and the converging tile which produces a shorter, narrower, more well-defined flame.

Direct spark ignition is available on the BBG_ 204 through _212 burners, while gas pilot ignition is available on all BBG burners. On ratio turndown is approximately 10:1 on natural gas. If operating with excess air, thermal turndown is greater.

B. RECEIVING AND INSPECTION

Upon receipt, check each item on the bill of lading and/or invoice to determine that all equipment has been received. A careful examination of all parts should be made to ascertain if there has been any damage in shipment.



WARNING

Use care when handling as the equipment may be heavy, have sharp edges or dust/fibers from refractory or gasket material. Always wear personal protective gear and use appropriate equipment during handling and installation.

IMPORTANT

If the installation is delayed and the equipment is stored outside, provide adequate protection as dictated by climate and period of exposure. Special care should be given to all motors, bearings, refractory material and electronic devices, if applicable, to protect them from rain or excessive moisture.

C. BURNER CAPACITIES

BBG 1000 AND 2000 SERIES		BURNER MODEL				
SPECIFICATIONS		xx04	xx06	xx08	xx10	xx12
Capacity	(MMBTU/hr)	3.1	6.1	12	19	26
	(kW)	820	1,610	3,170	5,050	6,770
Air Capacity	(scfh)	32,000	63,500	124,500	198,000	265,000
	(nm ³ /hr)	857	1,701	3,335	5,304	7,099
Air Inlet Pressure	(in.w.c.)	27.7	27.7	27.7	27.7	27.7
	(mbar)	68.9	68.9	68.9	68.9	68.9
Gas Inlet Pressure	(in.w.c.)	1.5	11.6	12.0	3.7	5.8
	(mbar)	3.7	28.9	29.9	9.2	14.4
Flame Length	(ft)	5.8	8.0	10.0	12.0	14.0
	(m)	1.8	2.4	3.0	3.7	4.3
Flame Diameter	(ft)	1.5	2.0	3.0	4.0	4.0
	(m)	0.5	0.6	0.9	1.2	1.2

BBG 1000 AND 2000 SERIES		BURNER MODEL				
SPECIFICATIONS		xx14	xx18	xx20	xx24	
Capacity	(MMBTU/hr)	38	65	87	123	
	(kW)	10,130	17,110	23,010	32,530	
Air Capacity	(scfh)	397,000	670,000	898,025	1,275,000	
	(nm ³ /hr)	10,635	17,948	24,056	34,155	
Air Inlet Pressure	(in.w.c.)	27.7	27.7	27.7	27.7	
	(mbar)	68.9	68.9	68.9	68.9	
Gas Inlet Pressure	(in.w.c.)	1.5	11.8	2.2	2.9	
	(mbar)	3.7	29.4	5.5	7.1	
Flame Length	(ft)	15.0	17.0	18.0	25.0	
	(m)	4.6	5.2	5.5	7.6	
Flame Diameter	(ft)	4.5	5.0	4.5	5.0	
	(m)	1.4	1.5	1.4	1.5	

NOTES:

- Capacities based on Natural Gas with HHV of 1034 BTU/ft³ (Standard), and LHV of 10.21 kWh/nm³ (Metric), 0.59 S.G., and a stoichiometric ratio of 9.74:1 with burner firing into chamber under no pressure at 10% excess air.
- Air and fuel flows based on STP operating conditions at sea level and industry standard air and gas piping practices.
- Gas inlet pressure given for reference only and should not be used for measuring fuel flow to the burner.
- Flame lengths measured from end of the combustion tile.
- Burner is suitable for use on gaseous fuels other than Natural Gas and with combustion air other than ambient temperature, consult Hauck.

Table 1. Burner Capacities

D. DIMENSIONS

See appropriate Dimension sheet for detailed dimensional information.

E. INSTALLATION



WARNING

Use care when handling as the equipment may be heavy, have sharp edges or dust/fibers from refractory or gasket material. Always wear personal protective gear and use appropriate equipment during handling and installation. Be sure your installation conforms to appropriate safety guidelines for your application such as NFPA 86 or EN746.

NOTE

If the burner utilizes an ultraviolet (UV) scanner for flame supervision, the burner should be positioned so that the UV scanner is located above the horizontal centerline of the burner to prevent moisture and airborne debris from setting into the UV scanner port and blocking the lens.

Hauck BBG burners must be mounted on properly braced, rigid furnace structures capable of supporting the burner and tile weight (see Table 2).

Burner Model	Approx. Burner Net Weight	Approx. Refractory Tile Net Weight	Approx. Alloy Tile Net Weight
BBG_04	100 lb (45 kg)	95 lb (43 kg)	45 lb (20 kg)
BBG_06	350 lb (159 kg)	140 lb (63 kg)	95 lb (43 kg)
BBG_08	350 lb (159 kg)	140 lb (63 kg)	95 lb (43 kg)
BBG_10	370 lb (168 kg)	210 lb (95 kg)	110 lb (50 kg)
BBG_12	425 lb (193 kg)	300 lb (136 kg)	130 lb (59 kg)
BBG_114	580 lb (263 kg)	510 lb (231 kg)	150 lb (68 kg)
BBG_118	675 lb (306 kg)	540 lb (245 kg)	195 lb (88 kg)
BBG_120	912 lb (414 kg)	540 lb (245 kg)	195 lb (88 kg)
BBG_124	1,600 lb (726 kg)	1,200 lb (544 kg)	275 lb (125 kg)

Table 2. Burner and Tile Weights

Burner Mounting (see Figure 1 for Refractory Tile, Figure 2 for Alloy Tile)

1. Furnish an opening in the furnace shell 1" (25mm) larger than the outside diameter of the burner tile.
2. Weld the appropriate size studs of appropriate length to the furnace shell to accept the tile mounting flange.
3. Place the tile mounting gasket on the furnace studs.
4. Wrap tile with one layer of 1" (25mm) fiber rated for a higher temperature than the furnace. Secure fiber wrap with tape or twine to compress the ceramic fiber wrap and retain the fiber during installation.
5. Install the burner tile on the furnace shell and secure with appropriate lock washers and nuts.
6. Place the tile cushion gasket into the recess in the burner tile.
7. Place the burner mounting gasket over the studs on the burner tile flange.
8. Install the BBG burner on the burner tile flange and secure with appropriate lock washers and nuts.

9. From inside the furnace, pack ceramic fiber blanket rated for a higher temperature than the furnace into the annular opening between the burner tile and the furnace wall insulation or refractory. It is important that the fiber is well packed to ensure that the furnace shell, tile flange, burner flange, and associated gaskets are not damaged. Fiber must be repacked after initial firing of the burner. (Refer to Figures 1 or 2 for illustration)



WARNING

Refractory can be heavy and laden with dust or fibers, use care in lifting and always wear appropriate personal protective gear such as a respirator or dust mask around refractory or gasket material.

10. For installations where the furnace wall is thicker than the burner tile, a port flare must be provided at D° (see Figures 3 or 4 details). For recommended port design and features, use Figures 3 and 4 as a reference. Use high quality refractory materials with a sufficient temperature rating for the intended application.

NOTE

If the BBG burner was not supplied with a self-supporting refractory or alloy tile, then a field poured refractory port must be installed. Installation requirements are available for field poured refractory ports for BBG burners (reference Drawing X4195, including removable, reusable metal mandrels; consult Hauck.

Burner Mounting with customer supplied port (see Figure 3 or 4)

1. Furnish an opening in the furnace shell 1" (25mm) larger than the outside diameter of the burner.
2. Weld the appropriate size studs of appropriate length to the furnace shell to accept the burner mounting flange.
3. Place the burner mounting gasket on the furnace studs.
4. Place the tile cushion gasket into the recess in the burner tile.
5. Install the BBG burner on furnace wall to ensure correct fit-up.
6. Remove the burner prior to forming the burner port.
7. Form the burner port to dimensions per Figure 3 or Figure 4 using wood or metal mandrels centered on mounting plate studs. Mandrel dimensions must include sufficient draft or taper for easy removal.
8. For installations where the furnace wall is thicker than the burner port length, a port flare must be provided at D°. If required, a maximum straight extension of 6" (152mm) may be provided at the 'tile' discharge as shown in Figure 4. Use high quality refractory materials with a sufficient temperature rating for the intended application.
9. Hauck recommends refractory brick anchors or high temperature alloy anchors to secure the burner refractory mass to the furnace shell. Follow the refractory manufacturer's recommendations for anchoring and expansion joints to ensure there is no mechanical stress transmitted to the burner tile.
10. Install the burner assembly into the fully cured refractory port with the appropriate lock washers and nuts.

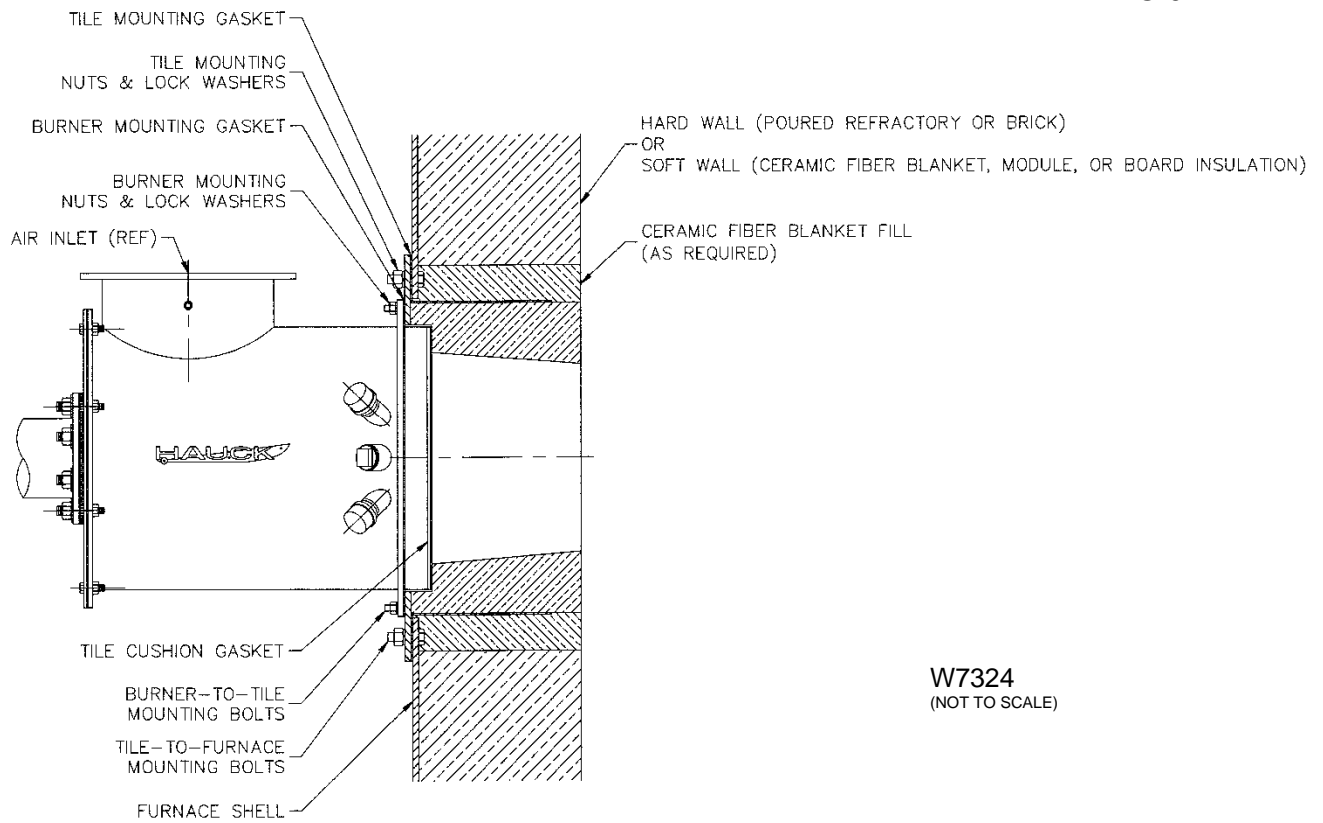

W7324
(NOT TO SCALE)

NOTE:

1. BURNER OUTLET MUST BE MOUNTED FLUSH WITH INSIDE WALL OR SLIGHTLY RECESSED.
2. CERAMIC FIBER BLANKET FILL MUST BE PACKED INTO ANNULAR VOID.

Figure 1. Burner Installation With Refractory Tile

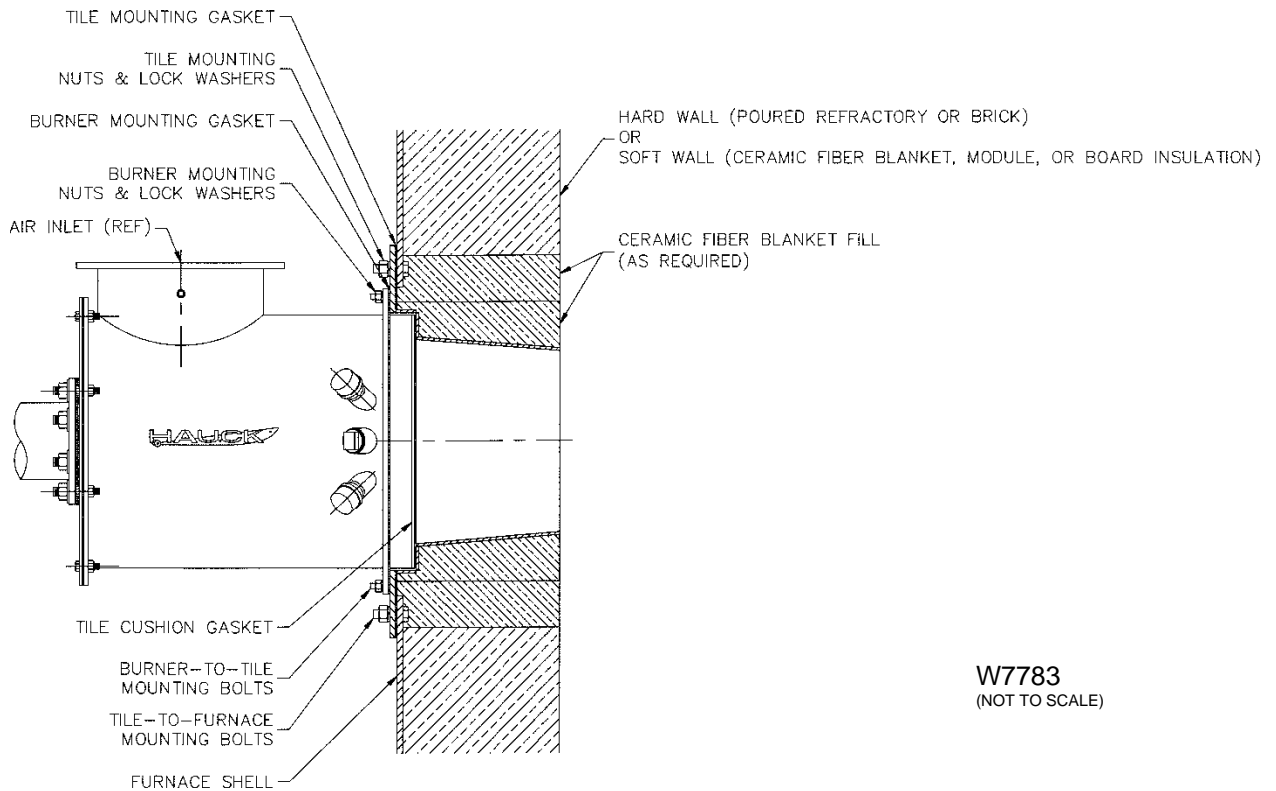

W7783
(NOT TO SCALE)

NOTE:

1. BURNER OUTLET MUST BE MOUNTED FLUSH WITH INSIDE WALL OR SLIGHTLY RECESSED.
2. CERAMIC FIBER BLANKET FILL MUST BE PACKED INTO ANNULAR VOID.

Figure 2. Burner Installation With Alloy Tile

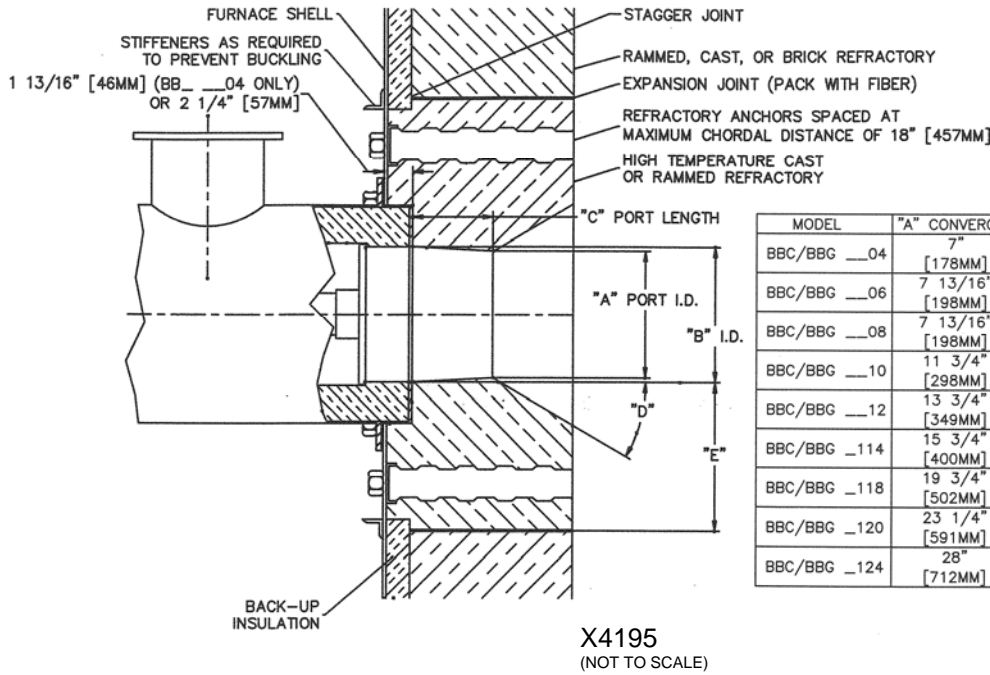

MODEL	"A" CONVERGING	"A" DIVERGING	B	C	D° MIN	E
BBC/BBG ___04	7" [178MM]	N/A	7 1/2" [191MM]	5" [127MM]	20°	9" [229MM]
BBC/BBG ___06	7 13/16" [198MM]	10 1/2" [267MM]	9 13/16" [249MM]	6 5/8" [168MM]	20°	9" [229MM]
BBC/BBG ___08	7 13/16" [198MM]	10 1/2" [267MM]	9 13/16" [249MM]	6 5/8" [168MM]	20°	9" [229MM]
BBC/BBG ___10	11 3/4" [298MM]	14 5/8" [371MM]	13 3/4" [349MM]	8 1/2" [216MM]	25°	9" [229MM]
BBC/BBG ___12	13 3/4" [349MM]	16 3/4" [425MM]	15 3/4" [400MM]	10 1/2" [267MM]	25°	9" [229MM]
BBC/BBG ___114	15 3/4" [400MM]	19 1/8" [486MM]	17 3/4" [451MM]	12 3/4" [324MM]	30°	10" [254MM]
BBC/BBG ___118	19 3/4" [502MM]	24" [610MM]	21 3/4" [552MM]	16 7/16" [418MM]	30°	10" [254MM]
BBC/BBG ___120	23 1/4" [591MM]	N/A	26" [660MM]	16 7/16" [418MM]	30°	10" [254MM]
BBC/BBG ___124	28" [712MM]	N/A	30" [762MM]	18 3/4" [477MM]	30°	14" [356MM]

Figure 3. Customer Supplied Refractory Port

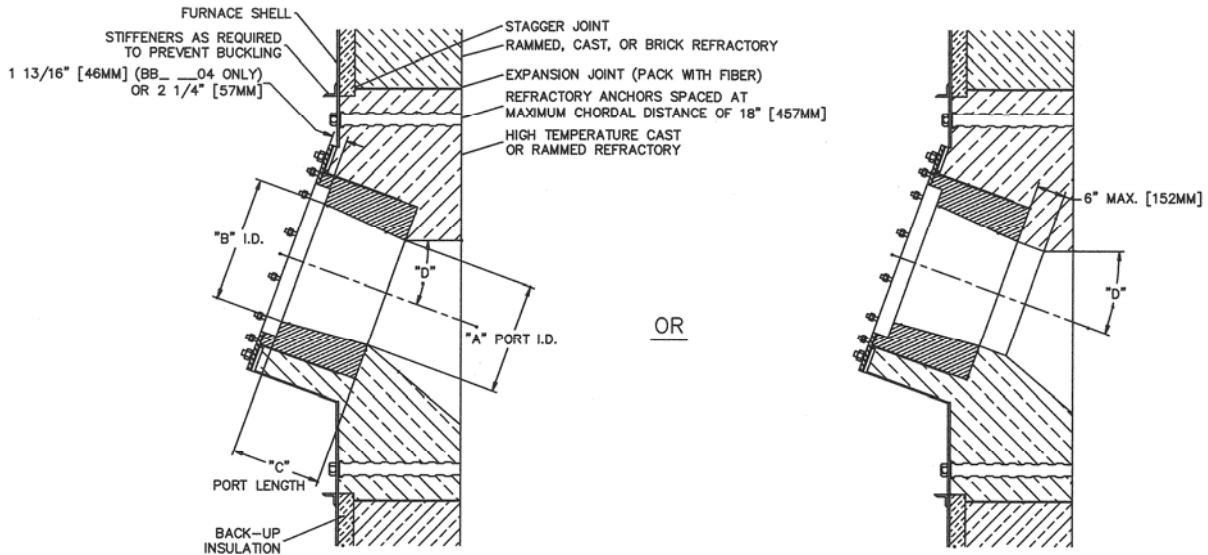

NOTE { INSTALLATION DETAIL SHOWN TO EMPHASIZE BURNER TILE/PORT GEOMETRY. FURNACE WALL SHOWN AS 'TYPICAL' REFRACTORY CONSTRUCTION; REFRACTORY AND WALL CONSTRUCTION DETAILS AND FABRICATION METHODS SHOULD BE COMPLETED BY QUALIFIED PERSONNEL. THE BURNER TILE AND/OR RAMMED REFRACTORY PORT MUST BE PROTECTED FROM MECHANICAL STRESS.

MODEL	A	B	C	D° MIN
BBC/BBG ___04	7" [178MM]	7 1/2" [191MM]	5" [127MM]	20°
BBC/BBG ___06	7 13/16" [198MM]	9 13/16" [249MM]	6 5/8" [168MM]	20°
BBC/BBG ___08	7 13/16" [198MM]	9 13/16" [249MM]	6 5/8" [168MM]	20°
BBC/BBG ___10	11 3/4" [298MM]	13 3/4" [349MM]	8 1/2" [216MM]	25°
BBC/BBG ___12	13 3/4" [349MM]	15 3/4" [400MM]	10 1/2" [267MM]	25°
BBC/BBG ___114	15 3/4" [400MM]	17 3/4" [451MM]	12 3/4" [324MM]	30°
BBC/BBG ___118	19 3/4" [502MM]	21 3/4" [552MM]	16 7/16" [418MM]	30°
BBC/BBG ___120	23 1/4" [591MM]	26" [660MM]	16 7/16" [418MM]	30°
BBC/BBG ___124	28" [712MM]	30" [762MM]	18 3/4" [477MM]	30°

X8427
(NOT TO SCALE)

Figure 4. Custom Installation For Thick Wall or Angle

Air and Fuel Connections

NOTE

All piping must be properly supported and aligned to avoid stresses on the burner and associated equipment. Hauck recommends that flexible connections be used on all air and fuel lines to isolate the burner from piping movement due to expansion, contraction, and vibration.

1. Install the air piping to the burner body using a flexible connection. Avoid elbows and abrupt directional changes in the piping where possible as turbulence can affect flow measurement accuracy, and reduce pressure at the burner.
2. If necessary, the gas connection on direct spark ignited BBG_ 204 through _ 212 burners can be rotated as follows:
 - a. Remove the screws and lock washers holding the gas inlet to the burner body.
 - b. Rotate the gas inlet until it is in the desired location.
 - c. Make sure the gasket between the gas inlet and the burner body is properly seated.
 - a. d. Replace the washers, hex nuts and securely tighten.
3. Install the gas line to the gas inlet using a flexible connection. Avoid elbows and abrupt directional changes in the piping where possible as turbulence can affect flow measurement accuracy, and reduce pressure at the burner.
4. For BBG burners using gas pilot ignition: Consult the appropriate dimensional sheet and instructions that accompany the pilot for additional information (IPG-9 or ZMI Literature).
 - a. BBG_104 through _120 IPG Gas Pilot
Install the pilot tip in the connection located above the burner center line on the burner body. Connect pilot air and gas to the appropriate connections on the gas pilot.
 - b. BBG_104 through _BBG112 ZMI Gas Pilot
Install the ZMI Pilot in the connection located on the burner gas inlet tee.
 - c. BBG_124 Forced Air Premix Pilot
Install the air/fuel premix outlet of the pilot manifold assembly to the pilot assembly. Connect pilot air and gas to the appropriate connections on the pilot manifold.

NOTE

All burner models are provided with two sets of connections for observation port, pilot and UV scanner mounting. Neither the pilot nor the UV scanner should be located below the horizontal centerline of the burner, where they could be adversely affected by dirt and debris. If the main air connection is at 6 or 12 o'clock, the accessory ports at either 3 or 9 o'clock can be used. However, **both the IPG pilot and UV scanner must be in adjacent ports on the same side of the burner.** If the main air connection is at 3 or 9 o'clock, use the IPG pilot and UV scanner connection ports located 180° from the main air connection. Scanner connection should be supplied with 1 psi of purge air.

NOTE

Size the pilot gas supply line to avoid excessive pressure drops. For supply lines up to 25 ft (7.6m) use 1/2" (DN 15) pipe; from 25 to 100 ft (7.6 – 30m) use 3/4" (DN 20) pipe. Prior to connecting to the pilot gas manifold, the gas line should be purged to remove debris.

NOTE

The BBG_124 UV scanner connections are positioned at 45° and 225° clockwise from the main air connection center line. Use guidelines in previous note to choose UV scanner port.

5. If an ultraviolet flame detection scanner is used, install it in the correct accessory port adjacent to the optional IPG pilot connection. Provide a clean, ambient air source for the UV scanner air purge by connecting the main air line to the 1/8 NPT (DN 6) air connection on the UV scanner adapter using 3/8" (1mm) OD tubing or larger and a suitable isolating valve.
6. If the observation port, IPG pilot, and UV scanner must be relocated during installation due to interferences with piping, etc., the alternate ports can be utilized as follows (see Figure 5):
 - a. Remove the pipe plugs (or caps) from the alternate port connections.
 - b. Remove the ceramic fiber insulation from the ports.
 - c. Insert a rod into each port and gently tamp on the plug of high temperature cement to dislodge the plug. **Use caution not to chip away refractory from the opening in the refractory ring.**
 - d. Insert the ceramic fiber insulation into the unused ports. **Failure to insert ceramic fiber insulation into the unused ports may result in damage to the outer metal burner housing.**
 - e. Secure the pipe plugs (or caps) in the unused port connections.
 - f. Install a thin coat of high temperature cement (Hauck recommends Resco Adamant or equivalent) over the original ports from the inside of the burner to contain the ceramic fiber insulation.

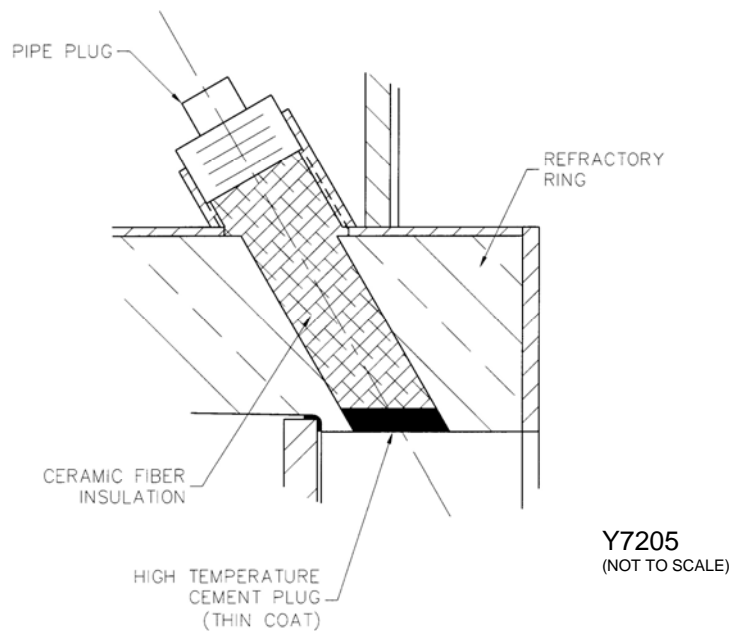

Figure 5. Port Sealing Arrangement

7. Verify that all piping connections are tight. Close all unused port openings on the burner body.
8. Inspect all bolted joints on the burner to ensure that all fasteners are tight and gaskets are properly seated.

CAUTION

In order to ensure an adequate seal, it is important that the burner backplate bolts be sufficiently tight. **Before any attempt is made to start the burner, check to ensure that the bolts are sufficiently tight and conduct a gas leak test. Failure to check and ensure that a satisfactory seal exists by conducting a leak test could result in the formation of a hazardous gas leakage condition.** Whenever burner internals are removed for cleaning or replacement, **be sure to tighten the backplate bolts and conduct a gas leak test.**

F. IGNITION



WARNING

Adjustment of this equipment by unqualified personnel can result in fire, explosion, severe personal injury, or even death.

BBG burners are available with an IPG of ZMI gas pilot igniter or an air-cooled spark igniter. **If using a Hauck IPG spark Ignited gas pilot or ZMI pilot see attached instructions for detailed operating instructions. Otherwise, see pilot vendor literature.** For either igniter, a 5000/6000 volt standard coil type ignition transformer or a half-wave "spark blind" solid state type transformer can be utilized. Both transformers yield satisfactory results, however, the standard coil type transformer provides reliable ignition over a wider range of air/fuel ratios than the half-wave type.



WARNING

When using a standard coil ignition transformer, provisions must be made to eliminate the ignition spark falsely satisfying the "flame on" UV scanner. Hauck designed flame supervisory panels accomplish this by "timing out" the spark transformer after a short (10 seconds for most applications) trial for ignition.

NOTE

Do not attempt manual ignition or torch lighting.

For IPG Gas Pilot Ignited Burners (BBG_104 through _120):

1. Ensure that the gas pilot igniter is threaded tightly into the pilot port.
2. Connect the high voltage ignition wire from the transformer to the spark plug on the gas pilot igniter. A snap-on ignition type connector is recommended.
3. **See attached IPG literature for detailed operating instructions.**

NOTE

- Beta Burner Model _104 uses a Hauck #1 pilot IPG5411A.
- Beta Burner Models _106 through _120 use a Hauck #3 pilot IPG5413A.
- Beta Burner Model _124 uses a Hauck forced air premix pilot, 58155.

For ZMI Gas Pilot Ignited Burners (BBG_304-E through _312-E):

1. Ensure that the ZMI gas pilot is threaded tightly into the pilot port.
2. See Dimensional Drawings for the proper insertion depth of the ZMI pilot and tighten the bushing to fix the position.
3. Connect the high voltage ignition wire from the transformer to the spark plug on the ZMI. A snap-on ignition type connector is recommended.
4. **See attached ZMI literature for detailed operating instructions.**

For Forced Air Premix Pilot (BBG_124 only), the pilot is integral through the burner. Refer to Figure 6 for pilot and manifold details.

1. The maximum gas supply pressure at the inlet to the pilot gas regulator is 5 psig (345 mbar). The regulated pilot gas supply to the gas limiting valve must be a nominal 20"wc (50 mbar).
2. The pilot gas regulator should be back-loaded from the chamber into which the burner is firing to ensure optimum pilot performance.

3. Ensure that the spark wire gap in the pilot is $3/32"$ (2.4mm). If the gap must be adjusted, carefully remove the pilot internals and bend the spark wire as required. Reinsert the pilot internals and check the gap.
4. Ensure that premix pilot igniter is bolted securely to burner backplate.
5. Connect the high voltage ignition wire from the transformer to the spark plug on the premix pilot igniter. A snap-on ignition type connector is recommended.
6. Set pilot air butterfly valve at position 5 (i.e., half open). Pilot air supply pressure at the inlet of the air butterfly valve must be a nominal 14"wc (35 mbar).

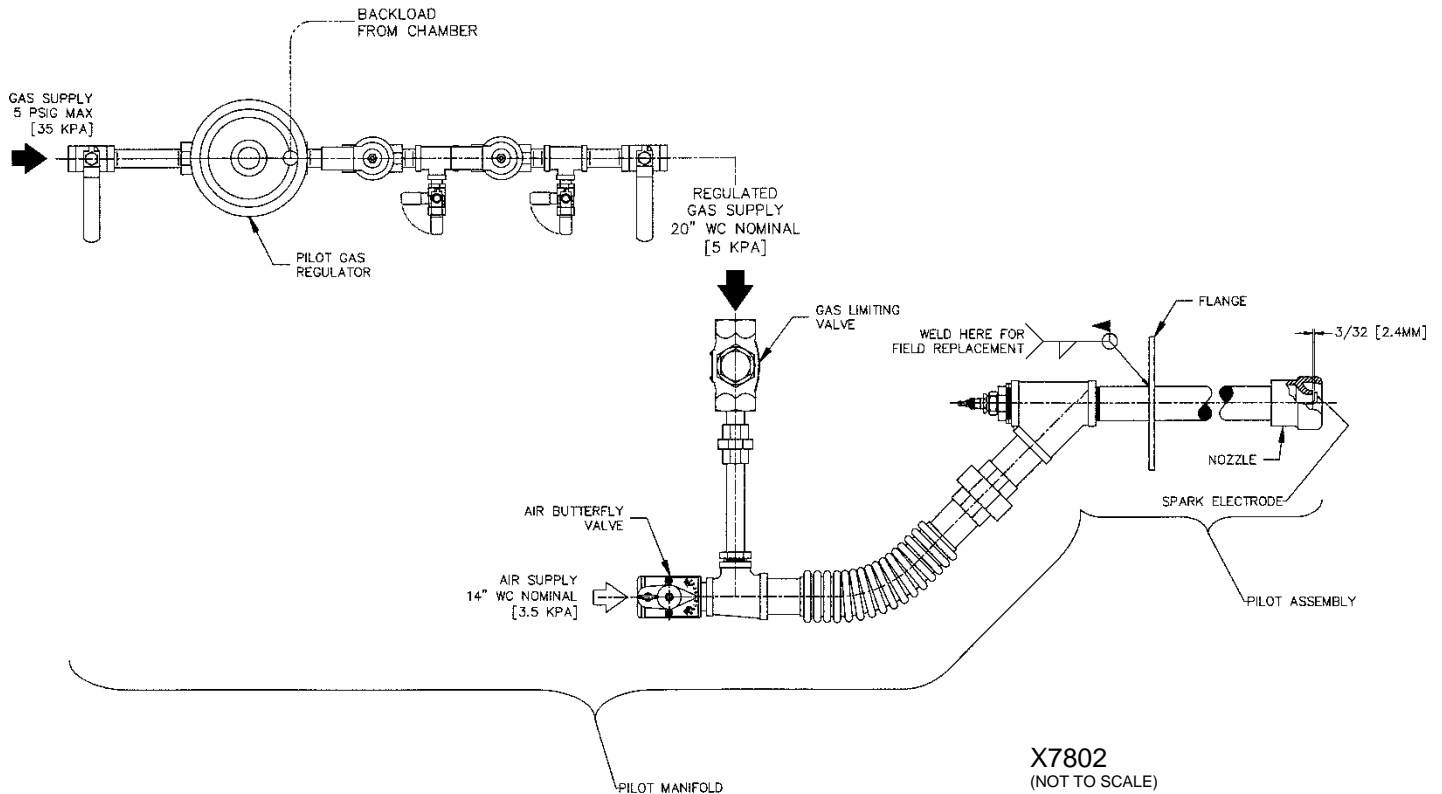

Figure 6. Pilot and Manifold Assembly Setup (Used W/BBG_124)

7. Remove the hex screw cap from the gas limiting valve and set the adjustment screw 4 turns from the fully closed position. This initial setting may be changed during final pilot adjustment; clockwise rotation decreases gas flow and counterclockwise rotation increases gas flow. Replace the hex screw cap when adjustment is complete.

CAUTION

The pilot ignition transformer can cause an electric shock - use care around the ignition cable. When test firing the pilot, leave pilot gas on briefly. If pilot does not light quickly, shut it off and repurge before attempting to relight.

8. Energize the ignition transformer, and supply air and then gas to the pilot manifold. Observe the pilot flame through one of the observation ports on the side of the burner. Adjust the pilot gas limiting valve (and pilot air butterfly valve if necessary) until a strong stable pilot flame is obtained.
9. De-energize the ignition transformer, stop the gas supply first and then the air supply.

If replacing the forced air premix pilot, be advised that the pilot and mounting flange are separate for ease of installation. The pilot and bracket must be welded once installed to ensure an air-tight connection through the backplate of the burner.

For Air-Cooled Direct Spark Ignited Burners (BBG_204 through _212):

1. Constant ambient air at a pressure ranging from 13.9 – 27.7"wc (34.5 – 68.9 mbar) must be available at the inlet to the air-cooled direct spark igniter to allow proper cooling when the burner is firing.
2. Disconnect cooling air from spark igniter and remove spark igniter from burner.
3. Connect ignition wire to spark igniter electrode connection.
4. Energize the ignition transformer and verify that an adequate spark is produced between the bent electrode tip and the outer tube.

CAUTION

The ignition transformer can cause an electric shock. Use care around the ignition cable. The igniter should be electrically grounded and should **NOT** be handled while the transformer is energized.

5. De-energize ignition transformer.
6. If the spark is adequate, re-install spark igniter into burner. If the spark is weak or absent, adjust the spark gap as shown in Figure 7 and repeat until adequate spark is obtained.
7. See dimensional drawing for the correct insertion depth of the spark igniter.

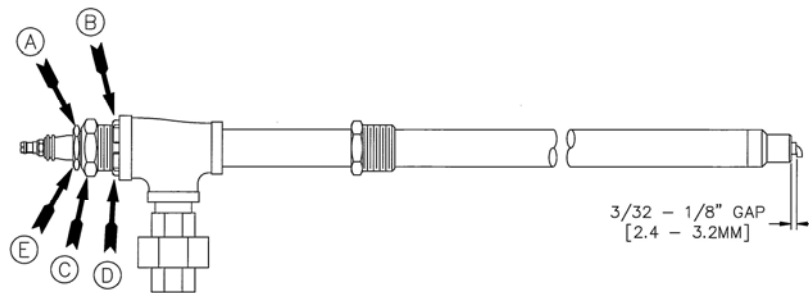

SPARK GAP ADJUSTMENT INSTRUCTIONS

- (A) NOTE POSITION OF BENT ELECTRODE TIP AT OPPOSITE END AND LOOSEN SPARK IGNITER BUSHING.
- (B) LOOSEN LOCKNUT
- (C) TURN SPARKPLUG ADJUSTMENT NUT TO ACHIEVE DESIRED SPARK GAP
- (D) TIGHTEN LOCKNUT
- (E) TIGHTEN SPARK IGNITER BUSHING
NOTE: DO NOT OVERTIGHTEN OR INSULATOR WILL CRACK

W7650
(NOT TO SCALE)

Figure 7. Air-Cooled Spark Igniter Gap Adjustment

G. INITIAL SETUP

BBG burners typically operate with automatic control systems. The burners are capable of proportional control over their entire capacity range. In a typical system, ignition will be preceded by a series of steps.

CAUTION

All cast refractory burner components are porous and therefore subject to moisture absorption. Refractory components should not be stored or exposed to damp conditions potentially reducing their normal expected life. Care **must** be taken at initial startups and after extended idle times to assure refractory components have been sufficiently dried prior to normal firing conditions. **Low fire drying for at least 6-8 hours at 100% excess air is required** at initial startup prior to exposing refractory components to normal firing operation. Thereafter, if the refractory components are exposed to excessive moisture, condensation, or high humidity for extended periods, **at least 30 minutes of low fire drying at 100% excess air is required** before beginning normal operation. Failure to do so may cause any moisture present to expand rapidly resulting in refractory spalling and/or premature failure.

CAUTION

Initial adjustment and burner start-up should be undertaken only by trained and experienced personnel familiar with combustion systems, control and safety circuitry and overall installation procedures. Avoid burns from flame, high surface temperature, hot components and exhaust gas. Verify proper installation and condition of gaskets & seals. In addition to heat and noise; burning paint (solvents or sealing material), exhaust leaks, carbon monoxide (CO) and other by-products of the combustion process may be present at or near the combustion equipment. Always wear appropriate clothing and personal protective gear (gloves, ear plugs, safety glasses, respirator, etc.) when working with equipment in operation.

CAUTION

Ensure that all safety equipment and limits are working properly before proceeding.

CAUTION

Failure to achieve ignition of pilot or main flame within a safe period (10 seconds) could result in a build-up of a combustible gas mixture which could lead to an explosion. In the event that the pilot or main flame does not light within the above time period, shut off fuel valves and re-purge the chamber before attempting further adjustment.

1. Once installed, the burner is ready for initial setup. The specific operation of the burner will depend on the individual system components in the entire combustion system. Refer to the instruction sheets that accompany the individual components.
2. Combustion air pressure should be set at the combustion air control valve. Typical combustion air pressure range from a minimum of approximately 0.3"wc (0.7 mbar) to a maximum of 27"wc (69 mbar) static pressure at the provided burner test points. Hauck recommends that the combustion air setting remain at minimum until the burner has been ignited (refer to the appropriate capacity sheet for burner air flow at low fire conditions).
3. Gas pressure should be set at the gas control valve. Nominal natural gas pressure required at the burner is approximately 6.9"wc at maximum capacity (17.4 mbar). Actual gas pressure required may vary (refer to the appropriate capacity sheet for burner gas flow at low fire conditions).
4. If not previously completed, refer to Section F for setup of the gas pilot igniter or the air-cooled direct spark igniter.
5. Once the igniter is set and the initial gas and air adjustments are made, the burner can be ignited as follows:
 - a. Be sure that all fuel shutoff valves are closed and all control valves are in the low fire position.
 - b. Start the combustion air blower

For Gas Pilot Ignition:

- c. Ensure that the pilot automatic safety solenoid valves and the pilot manual gas valve are closed.
- d. Energize the igniter transformer.
- e. Open the pilot gas automatic safety shutoff solenoid valves and the pilot manual gas valve.
- f. Once the pilot flame has been established (confirm using flame supervision), de-energize the ignition transformer.
- g. Open (energize) the main automatic gas or oil safety shutoff valves.
- h. Once flame has been established, the pilot gas automatic safety shutoff valves may close. Leave the manual pilot air valve in position.
- i. Proceed to ignite all burners (if applicable) per the above procedure.

For Air-Cooled Direct Spark Ignition:

- c. Energize the ignition transformer.
- d. Open (energize) the main automatic gas safety shutoff valves.
- e. Once flame has been established de-energize the ignition transformer.
- f. Proceed to ignite all burners (if applicable) per the above procedure.
6. When all burners are ignited, increase the combustion air to the high fire position (refer to appropriate capacity sheet for burner air flow at high fire conditions).
7. When high fire combustion air is set, adjust the gas control valve (limiting gas valve or automatic butterfly valve) to achieve the desired gas flow at high fire (refer to appropriate capacity sheet for burner gas flow at high fire conditions).
8. Verify air/fuel ratio using orifice meters in the air and gas lines. Static air pressure at the burner air inlet can be related to air flows if an air orifice meter is not available. Static gas pressure is very low and should not be used to extrapolate flows.
9. Drive the burner to the low fire position and verify that the settings are consistent. Repeat steps 6 through 9 as necessary until high and low fire settings remain constant.
10. Lock all control motor linkage or direct-couplings in place and return all control system functions to normal, if changed during initial adjustments.
11. To shut down the burner system:
 - a. Return the burner(s) to the low fire position.
 - b. Close all fuel shutoff valves.
 - c. Allow the furnace to cool to 300°F (150°C) or less before shutting off the combustion air blower.

H. OPERATION

Once properly installed, ignited and fired, the burner is ready for operation. The operation of the burner will depend on the specific items in the combustion control system and the application of the burners. Refer to the instruction sheet that accompanies each item. The burner should always be ignited under low fire conditions. When the burner is firing, the spark igniter or gas pilot should be shut off. If the burner ignition tile is exposed to excessive moisture or extended periods of dampness, **at least 30 minutes of low fire drying at 100% excess air is required before beginning normal operation. Failure to do so will cause any moisture present to expand rapidly, causing damage to the refractory.**

I. MAINTENANCE

CAUTION

Be sure burner internals have cooled sufficiently before attempting to disassemble any components. Use care when separating gasket surfaces to avoid damage to the gaskets. All maintenance work should be accomplished by trained and experienced personnel only.

Hauck Beta Burners have been carefully engineered to provide dependable performance while requiring low maintenance. As with any product, it is very important to follow operating

instructions and all procedures carefully to obtain optimum performance. Please refer to the applicable Beta Burner Parts List to become familiar with the various burner components and assemblies.

1. Inspection and cleaning of the burner gas body assembly
 - 1) Disconnect the gas line.
 - 2) Remove the air-cooled direct spark igniter or ZMI pilot (if applicable).
 - 3) Remove front set of nuts and washers from air body backplate.
 - 4) Remove gas tee from burner.
 - 5) Inspect internal parts. Clean the interior walls of gas body assembly and gas tube assembly of any residue.
 - 6) Check condition of internal baffle and clean main air openings in baffle, if needed.
 - 7) Reinsert gas tee making sure that the gasket is properly seated and connections properly oriented.
 - 8) Replace nuts and washers and securely tighten.
 - 9) Reconnect the gas line.

CAUTION

Failure to check and ensure that a satisfactory seal exists by conducting a gas leak test could result in a hazardous condition.

2. Replacement of internal baffle (F Model Burners)

In certain situations, it may become necessary or desirable to replace the internal baffle of the burner. The baffle on the 1000 series Beta Burner is made of stainless steel, while the baffles on 2000 and 3000 series burners are made of high temperature refractory. In order to replace the internal baffle, use the following procedure:

- 1) Disconnect fuel line.
- 2) Loosen the backplate bolts.
- 3) Remove burner backplate and gas tube. Be careful not to damage the internal body insulation (BBG 3000 series).

For 1000 series (stainless steel baffle):

- a. Remove the brass nuts on the baffle retaining clips inside the burner.
- b. Remove the old stainless steel baffle and replace with the new part, making sure it seats against the step in the refractory ring.
- c. Coat the edge surface between the stainless steel baffle and the refractory ring to ensure that air does not penetrate the joint. Hauck recommends a high temperature sealant such as Fiberfrax QF-150 or equivalent.
- d. Replace the baffle retaining clips and brass nuts.

For 2000 and 3000 series (refractory baffle):

- a. Break the seal around refractory baffle edges at the refractory ring and remove from burner.
- b. Remove the old refractory baffle and replace with the new part, making sure it seats against the step in the refractory ring. Coat the edge surface between the refractory baffle and the refractory ring to ensure that air does not penetrate the joint. Hauck recommends a high temperature sealant such as Fiberfrax QF-150 or equivalent.
- 4) Replace the burner backplate gasket if required.
- 5) Replace the burner backplate assembly, re-torqueing all bolts to 30 ft-lb (41 Nm).
- 6) Reconnect the seal at the backplate bolts and any other joints where the possibility of a gas leak exists.



WARNING

Use care when handling as the equipment may be heavy, have sharp edges or dust/fibers from refractory or gasket material. Always wear personal protective gear and use appropriate equipment during handling and installation. Verify proper installation and condition of gaskets & seals. Damaged gaskets or seals could allow the escape of hot gases or eject hot material.

2A. Replacement of Internal Baffle (04,14,18,20 and 24 size burners)

In certain situations, it may become necessary or desirable to replace the internal baffle of the burner. The baffle on Beta Burner 1_00 series models is made of high temperature stainless steel, while the baffles on 2_00 and 3_00 series burners are made of high temperature refractory. In order to replace the internal baffle, use the following procedure:

- a. Disconnect fuel line.
- b. Loosen the backplate bolts.
- c. Remove burner internals after breaking the seal between the internal baffle and the main tile. Be careful not to damage the internal body liners (BBG 3_00 models).
- d. For 1_00 series models (stainless steel baffle):
 - (1) Remove (3) 1/4" hex head cap screws and baffle from gas tube.
 - (2) Place new baffle on gas tube.
 - (3) Replace hex screws and tighten.
- e. For 2_00 and 3_00 series models (refractory baffle):
 - (1) If baffle has remained attached to gas tube, separate baffle from tube.
 - (2) If baffle has remained inside burner after removal of gas tube, break seal around baffle edges and remove from burner.
 - (3) Clean any residue from gas tube.
 - (4) Replace gasket around gas tube.
 - (5) Carefully place new baffle on gas tube and press fit.
- f. For all models:
 - (1) Coat outer edges of new baffle with 1/8" (3mm) thick layer of high temperature coating cement (Hauck recommends Fiberfrax QF-150 or equivalent).
 - (2) Replace the existing gasket (if undamaged).
 - (3) Carefully replace entire assembly, making sure baffle is centered in burner and has seated against refractory step.
 - (4) Reattach internal assembly to the main air body by tightening the backplate bolts.
 - (5) Torque the backplate bolts to 30 ft-lb (41 Nm).
 - (6) Reconnect the seal at the backplate bolts and any other joints where the possibility of a gas leak exists.

3. Replacement of Burner Tile

Tiles should be checked for coke/residue build-up or damage. If this cannot be done from inside the furnace, it will be necessary to gain access to the tile by removing the burner backplate assembly as described in step 2. Should it ever become necessary to replace the burner tile, use the following procedure:

- 1) Disconnect all fuel and air piping from burner.
- 2) Remove flame scanning equipment, and gas pilot or direct spark igniter from accessory ports (if applicable).
- 3) Support the burner weight before loosening mounting nuts.
- 4) Loosen the burner mounting nuts from the burner mounting studs and remove the burner assembly from the furnace.
- 5) Loosen and remove the tile mounting nuts from the mounting plate studs.
- 6) Remove the existing burner tile from the furnace wall and clean the tile port opening.
- 7) Inspect the furnace wall insulation or refractory in the area surrounding the tile and repair any damage.
- 8) Replace the burner tile mounting gasket.
- 9) Replace the tile cushion gasket into the recess in the burner tile.
- 10) Mount the new burner tile.
- 11) Replace tile mounting nuts and tighten.
- 12) Reinstall all flame scanning equipment and gas pilot or direct spark igniter in appropriate ports (if applicable).
- 13) Reconnect all fuel and air piping to the burner and check for gas leaks before restarting the burner.

J. RECOMMENDED SPARE PARTS LIST

Item	Qty.	Part Number	Description
1	1	See Parts List	Gas Pilot, Igniter (If Applicable)
2	1	See Parts List	Direct Spark Igniter Assembly (If Applicable)
3	1	See Parts List	UV Scanner (If Applicable)
4	1	See Parts List	Flamerod (If Applicable)
5	1	See Parts List	Gasket

Table 3. Recommended Spare Parts

IPG GAS PILOT BURNERS

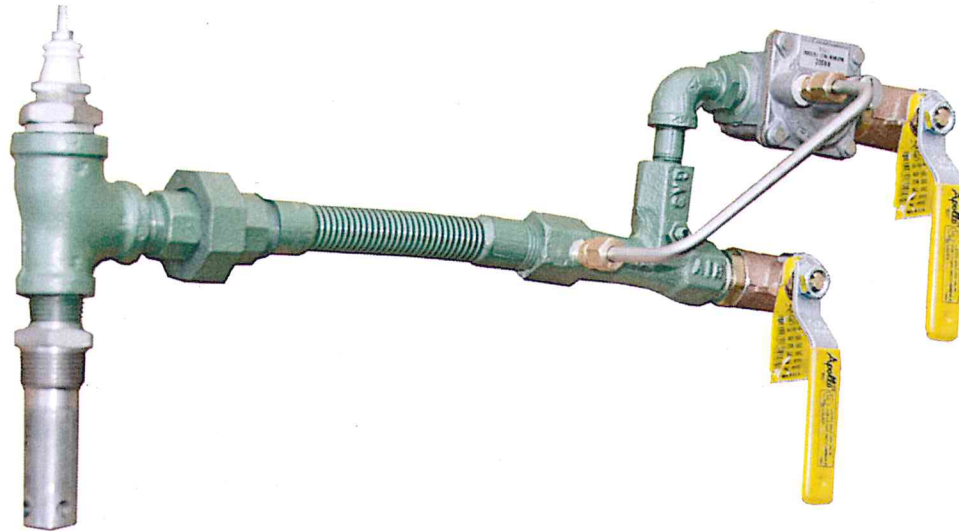

WARNING

These instructions are intended for use only by experienced, qualified combustion start-up personnel. Adjustment of this equipment and its components by unqualified personnel can result in fire, explosion, severe personal injury, or even death.

TABLE OF CONTENTS

	<u>Subject</u>	<u>Page</u>
A.	General Information	2
B.	Receiving and Inspection	2
C.	Capacities	3
D.	Dimensions	6
E.	Installation	6
F.	Ignition.....	6
G.	Operation.....	9
H.	Shutoff Valve Leak Testing.....	9
I.	Maintenance.....	9

These instructions are intended to serve as guidelines covering the installation, operation, and maintenance of Hauck equipment. While every attempt has been made to ensure completeness, unforeseen or unspecified applications, details, and variations may preclude covering every possible contingency. **WARNING: TO PREVENT THE POSSIBILITY OF SERIOUS BODILY INJURY, DO NOT USE OR OPERATE ANY EQUIPMENT OR COMPONENT WITH ANY PARTS REMOVED OR ANY PARTS NOT APPROVED BY THE MANUFACTURER.** Should further information be required or desired or should particular problems arise which are not covered sufficiently for the purchaser's purpose, contact Hauck Mfg. Co.



WARNING

This equipment is potentially dangerous with the possibility of serious personal injury and property damage. Hauck Manufacturing Company recommends the use of flame supervisory equipment and fuel safety shutoff valves. Furthermore, Hauck urges rigid adherence to National Fire Protection Association (NFPA) standards and insurance underwriter's requirements. Operation and regular preventative maintenance of this equipment should be performed only by properly trained and qualified personnel. Annual review and upgrading of safety equipment is recommended.

A. GENERAL INFORMATION

The Hauck Series IPG Gas Pilot provides a means of lighting the flame of Hauck burners and many other industrial gas or oil burners. IPG pilots are engineered for exceptional flame stability and long life, even under the most severe and adverse operating conditions. IPG pilots are designed for electric spark ignition. The standard IPG Gas Pilots are suitable for firing into neutral, negative or positive pressure applications.

The back-loaded feature offers the capability to compensate the pilot air/fuel ratio for variations in furnace or burner pressure.

B. RECEIVING AND INSPECTION

Upon receipt, check each item on the bill of lading and/or invoice to determine that all equipment has been received. A careful examination of all parts should be made to ascertain if there has been any damage in shipment.

IMPORTANT

If the installation is delayed and the equipment is stored outside, provide adequate protection as dictated by climate and period of exposure. Special care should be given to all motors and bearings, if applicable, to protect them from rain or excessive moisture.

C. CAPACITIES

IPG_411 Pilot

NATURAL GAS, AMBIENT COMBUSTION AIR OPERATION

SPECIFICATIONS		OPERATIONAL INFORMATION			
Capacity (at 10% Excess Air)	(BTU/hr)	11,000	16,000	18,000	20,000
	(kW)	2.9	4.2	4.8	5.3
Air Capacity	(SCFH)	115	160	180	208
	(nm ³ /hr)	3.1	4.3	4.8	5.6
Air Pressure (to the mixing tee)	(in.w.c.)	13.9	27.7	41.5	55.4
	(mbar)	34.6	68.9	103.3	137.8
Gas Pressure (to inlet of regulator)	(in.w.c.)	13.9	13.9	13.9	13.9
	(mbar)	34.5	34.5	34.5	34.5
Pilot Mixture Pressure	(in.w.c.)	5.0	10.0	14.5	20.8
	(mbar)	12.4	24.9	36.1	51.8
Flame Length (at 10% Excess Air)	(in)	6.0	6.0	7.0	7.0
	(mm)	152	152	178	178
Operating Limits	(λ Max)	2.25	2.00	1.85	1.75
	(λ Min)	0.65	0.85	0.90	0.95

NOTES

1. Capacities based on Natural Gas with HHV of 1034 BTU/ft³ (Standard), and LHV of 10.21 kWh/nm³ (Metric), 0.62 S.G., and a stoichiometric ratio of 9.74:1 with burner firing into chamber under no pressure at 10% excess air.
2. Air and fuel flows based on STP operating conditions at sea level and industry standard air and gas piping practices.
3. Air flow to the pilot to be ambient temperature air with a minimum supply pressure of 13.9 in.w.c., or 34.5 mbar, up to a maximum supply pressure of 56 in.w.c., or 140 mbar.
4. Fuel flow to the pilot to be ambient temperature with a minimum supply pressure of 13.9 in.w.c., or 34.5 mbar, up to a maximum supply pressure of 28 in.w.c., or 70 mbar.
5. Pilot is suitable for use on gaseous fuels other than Natural Gas, consult Hauck.

IPG_411 Burner Pressure Curves

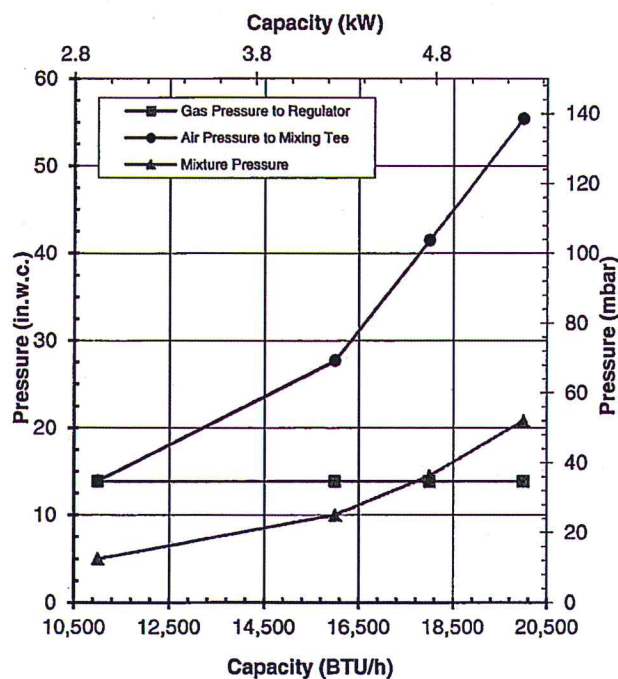

IPG_411 Operating Window

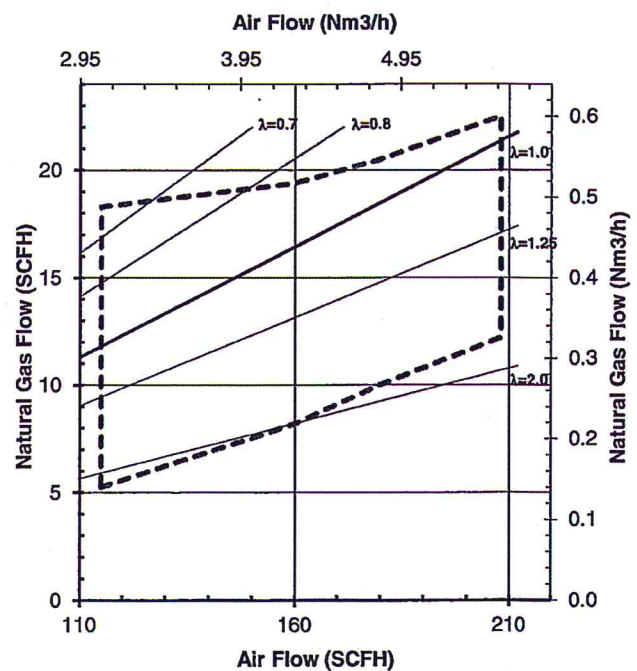

Table 1. IPG_411 Pilot

C. CAPACITIES (Continued)

IPG_412 Pilot

NATURAL GAS, AMBIENT COMBUSTION AIR OPERATION

SPECIFICATIONS		OPERATIONAL INFORMATION			
Capacity (at 10% Excess Air)	(BTU/hr)	26,000	35,000	43,000	50,000
	(kW)	6.9	9.3	11.4	13.2
Air Capacity	(SCFH)	265	365	441	510
	(nm ³ /hr)	7.1	9.8	11.8	13.7
Air Pressure (to the mixing tee)	(in.w.c.)	13.9	27.7	41.5	55.4
	(mbar)	34.6	68.9	103.3	137.8
Gas Pressure (to inlet of regulator)	(in.w.c.)	13.9	13.9	13.9	13.9
	(mbar)	34.5	34.5	34.5	34.5
Pilot Mixture Pressure	(in.w.c.)	3.3	6.2	9.0	11.7
	(mbar)	8.2	15.4	22.4	29.1
Flame Length (at 10% Excess Air)	(in)	8.0	9.0	10.0	12.0
	(mm)	203	229	254	305
Operating Limits	(λ Max)	2.00	1.75	1.60	1.55
	(λ Min)	0.62	0.86	1.00	1.05

NOTES

1. Capacities based on Natural Gas with HHV of 1034 BTU/ft³ (Standard), and LHV of 10.21 kWh/nm³ (Metric), 0.62 S.G., and a stoichiometric ratio of 9.74:1 with burner firing into chamber under no pressure at 10% excess air.
2. Air and fuel flows based on STP operating conditions at sea level and industry standard air and gas piping practices.
3. Air flow to the pilot to be ambient temperature air with a minimum supply pressure of 13.9 in.w.c., or 34.5 mbar, up to a maximum supply pressure of 56 in.w.c., or 140 mbar.
4. Fuel flow to the pilot to be ambient temperature with a minimum supply pressure of 13.9 in.w.c., or 34.5 mbar, up to a maximum supply pressure of 28 in.w.c., or 70 mbar.
5. Pilot is suitable for use on gaseous fuels other than Natural Gas, consult Hauck.

IPG_412 Burner Pressure Curves

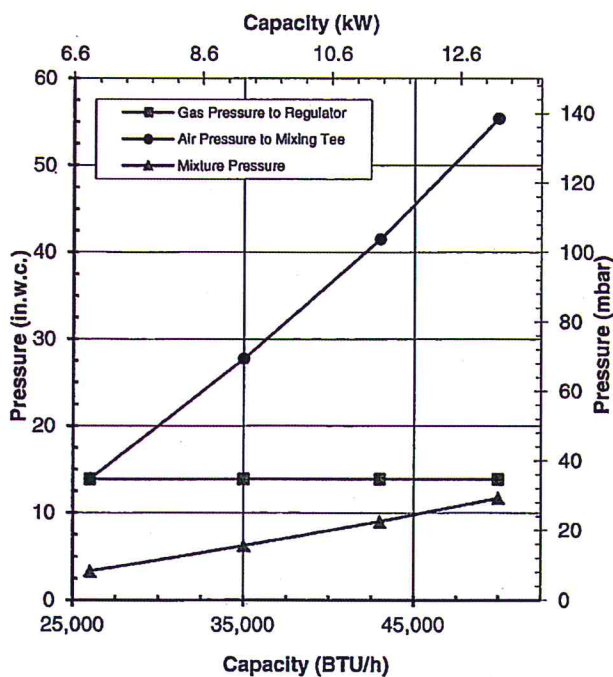

IPG_412 Operating Window

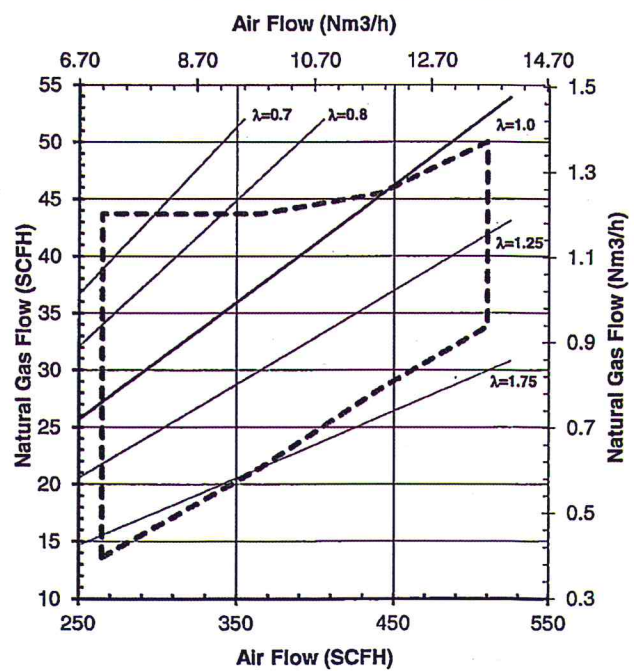

Table 2. IPG_412 Pilot

C. CAPACITIES (Continued)

IPG_413 Pilot

NATURAL GAS, AMBIENT COMBUSTION AIR OPERATION

SPECIFICATIONS		OPERATIONAL INFORMATION			
Capacity (at 10% Excess Air)	(BTU/hr)	62,000	84,000	100,000	112,000
	(kW)	16.4	22.2	26.5	29.6
Air Capacity	(SCFH)	640	865	1,025	1,155
	(nm ³ /hr)	17.1	23.2	27.5	30.9
Air Pressure (to the mixing tee)	(in.w.c.)	13.9	27.7	41.5	55.4
	(mbar)	34.6	68.9	103.3	137.8
Gas Pressure (to inlet of regulator)	(in.w.c.)	13.9	13.9	13.9	13.9
	(mbar)	34.5	34.5	34.5	34.5
Pilot Mixture Pressure	(in.w.c.)	3.0	5.5	7.5	10.0
	(mbar)	7.5	13.7	18.7	24.9
Flame Length (at 10% Excess Air)	(in)	8.0	9.0	10.0	12.0
	(mm)	203	229	254	305
Operating Limits	(λ Max)	1.45	1.40	1.30	1.20
	(λ Min)	0.85	0.91	0.96	0.99

NOTES

1. Capacities based on Natural Gas with HHV of 1034 BTU/ft³ (Standard), and LHV of 10.21 kWh/nm³ (Metric), 0.62 S.G., and a stoichiometric ratio of 9.74:1 with burner firing into chamber under no pressure at 10% excess air.
2. Air and fuel flows based on STP operating conditions at sea level and industry standard air and gas piping practices.
3. Air flow to the pilot to be ambient temperature air with a minimum supply pressure of 13.9 in.w.c., or 34.5 mbar, up to a maximum supply pressure of 56 in.w.c., or 140 mbar.
4. Fuel flow to the pilot to be ambient temperature with a minimum supply pressure of 13.9 in.w.c., or 34.5 mbar, up to a maximum supply pressure of 28 in.w.c., or 70 mbar.
5. Pilot is suitable for use on gaseous fuels other than Natural Gas, consult Hauck.

IPG_413 Burner Pressure Curves

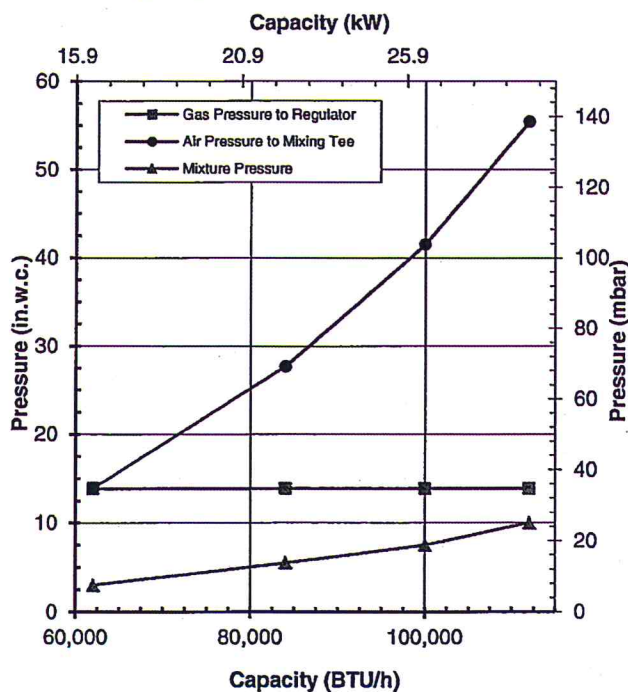

IPG_413 Operating Window

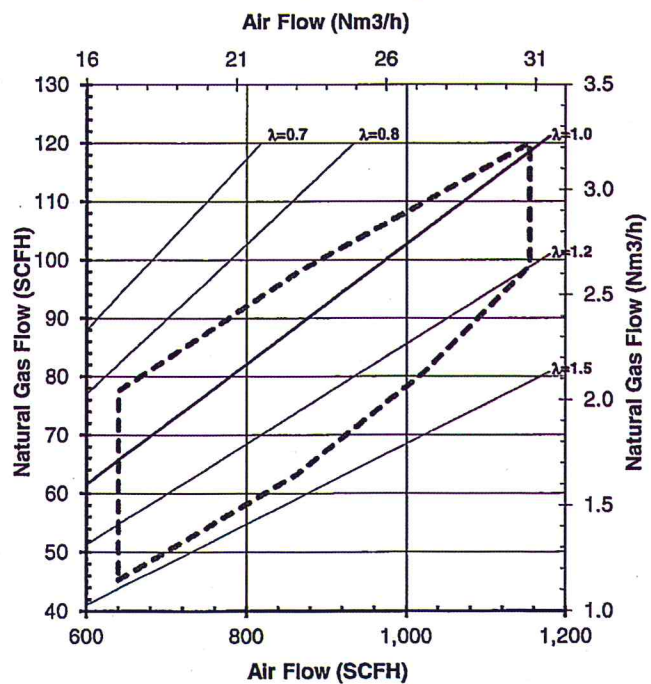

Table 3. IPG_413 Pilot

D. DIMENSIONS

See appropriate Dimension sheet for detailed dimensional information.

E. INSTALLATION

1. Ensure that all components of the factory assembled pilot are present and properly connected. The pilot unit consists of a low pressure gas regulator, air ball valve, gas ball valve, gas mixer, pilot nozzle assembly, union (threaded pilots only), and flexible pipe nipple.
2. Install the pilot assembly in the air and gas lines. The gas pressure regulator is used as a zero governor and is suitable for any mounting position without restriction.
 - a. Connect the air piping to the inlet side of the air ball valve. Low pressure air should be supplied at a constant pressure ranging from 14 - 55"w.c. (35 – 137 mbar) at the inlet of the ball valve.
 - b. Connect the gas piping to the inlet side of the gas ball valve. Low pressure gas should be supplied at approximately 14"w.c. (35 mbar) at the inlet of the regulator. The regulator is designed to operate from 13.9 - 27.7"w.c. (34.5 – 68.9 mbar); maximum allowable inlet pressure is 27.7"w.c. (68.9 mbar).
 - c. Ensure that the air and gas ball valves are fully closed.

F. IGNITION



WARNING

Adjustment of this equipment by unqualified personnel can result in fire, explosion, severe personal injury, or even death.

NOTE

To reduce pressure losses, use adequate sized pipe and minimize elbows in the air and gas lines to the pilot assembly. It is recommended that the air and gas supply be equal to or greater than their respective pilot air and gas connection sizes. If the pilot is installed at the end of a long run of pipe or will be operated in a dirty environment, it is recommended that a sediment trap be installed in the pilot air line.

1. Be sure the spark plug is set as shown in Figure 1. Ideally, initial pilot set-up should be done with the pilot outside of the burner.
2. Connect a 5000/6000 volt standard coil type ignition transformer to the spark plug on the spark igniter using a high voltage ignition wire. Ensure that the spark plug's wire electrode is centered in the pilot nozzle.

F. IGNITION Continued)

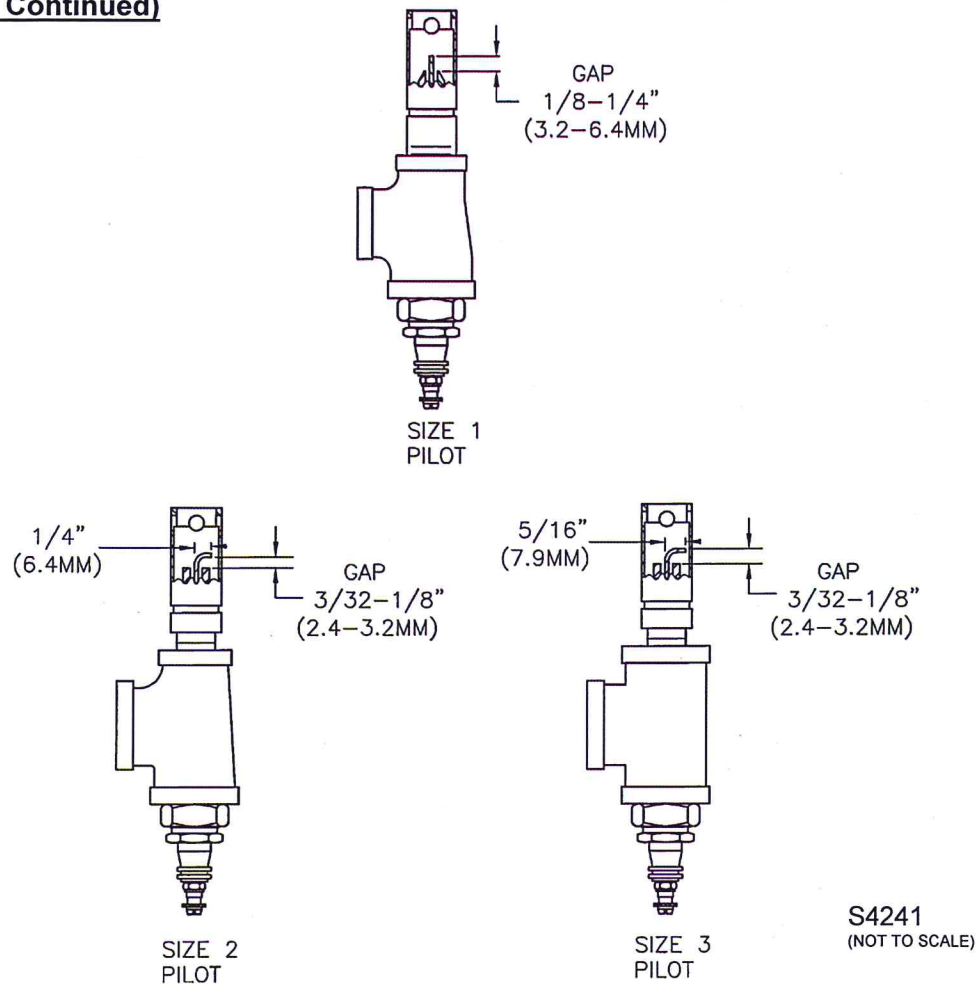

Figure 1. Spark Gap Setting and Electrode Positioning

NOTE

Ensure pilots are properly grounded to prevent equipment damage or personal injury. Exercise care to avoid over-tightening the spark plug holding nut as this may crack the ceramic insulator of the plug. Avoid, where possible, the use of long ignition wires. Long ignition wire can cause rapid spark plug wear or erosion. Suggested methods to avoid this problem are explained in Application Sheet GJ57.

CAUTION

Ignition of the pilot results in a high voltage spark in excess of 5000 volts and an open flame. Remain clear of ignition wire, spark plug and pilot nozzle while firing the pilot.

CAUTION

The ignition transformer can cause an electric shock. Use care around the ignition cable. The igniter should be electrically grounded and should **NOT** be handled while the transformer is energized.

3. Ensure that the gas ball valve is closed.
4. Start the blower or air supply.
5. Open the air ball valve to the full open position.
6. Energize the ignition transformer and verify that an adequate spark is produced.
7. **Open the gas ball valve fully. This ball valve should be open fully at all times when the pilot is burning.**
8. The set screw on the air/gas mixer (Figure 2) is used to control the air/fuel ratio of the IPG pilot. The pilot **MUST** be properly set up prior to use as a burner ignition source. If the pilot is not set up, it may fail to light burner. The pilot should be set according to the following procedure with pilot outside of the burner:
 1. Ignite the pilot.
 2. Loosen the jam nut on the mixer.
 3. Rotate the set screw to adjust the mixer to the desired air/fuel ratio; clockwise for leaner, and counter clockwise for richer.
 4. The pilot will be at the proper air/fuel ratio when small flames become visible at the holes in the pilot nozzle. Some reddening of the pilot nozzle may occur. The flame should appear short, sharp, and blue. A yellow flame indicates that the mixture is too rich and adjustment is required for proper ignition.
 5. Hold the set screw in place at the desired position and tighten the jam nut.

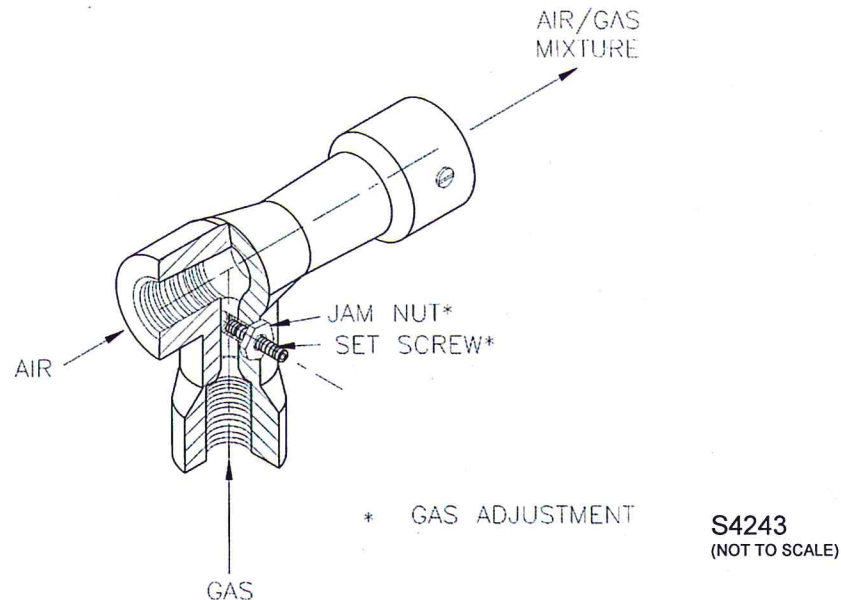

Figure 2. Pilot Mixer Adjustment

9. To extinguish the pilot:
 - a. Close gas ball valve first.
 - b. Close air ball valve last (if desired).
10. Insert a slip-fit pilot into the burner and tighten the setscrew on the burner to lock the pilot nozzle in place (if applicable).

11. Insert a threaded pilot as follows:
 - a. Disconnect the union between the pilot nozzle and flex nipple.
 - b. Thread the pilot into the port and wrench tighten until snug.
 - c. Reconnect the union.

NOTE

The pilot nozzle tip should be located slightly behind the main burner nozzle discharge area so that it will not obstruct or be affected by the air/fuel discharge of the main burner.

G. OPERATION

When properly adjusted, the pilot should produce a sharp, short, blue flame. If adjustment is necessary, refer to the Ignition section.

H. SHUTOFF VALVE LEAK TESTING

Both safety shutoff valves in the gas pilot manifold must be leak tested by qualified personnel as recommended by NFPA 86.



WARNING

Do not attempt to operate a combustion system with leaks present.

I. MAINTENANCE

All components of the pilot assembly are engineered to provide maintenance free operation. It is sometimes necessary, however, to clear the mixer jet of any debris as this causes mixer capacity to diminish. The mixer jet is easily cleaned by removing the air piping downstream of the air ball valve and running a wire into the mixing tee opening through the jet. The gas inlet of the mixer can also be cleaned by the same method. Fully removing the adjustment screw also provides access to clean the mixer.

The pilot nozzle may become plugged with debris or carbon buildup. To clean the nozzle, remove the pilot assembly from the burner. Disconnect the nozzle from the pilot assembly and remove the spark plug assembly. **Check carefully to ensure the ceramic insulator is not broken.** Clean the small tangential holes that surround the main hole and blow the nozzle out with air when complete. Reassemble the pilot assembly, test fire, and reinsert the pilot into the burner.

Periodically remove and inspect the spark plug. If the ceramic insulator is cracked or broken, replace it. Clean the unit of any carbon buildup. **When replacing the plug, avoid over-tightening the nut holding the plug to avoid cracking the plug's ceramic insulator.** Before use, ensure the plug's wire electrode is centered in the pilot nozzle (see Figure 1 for setting spark plug).

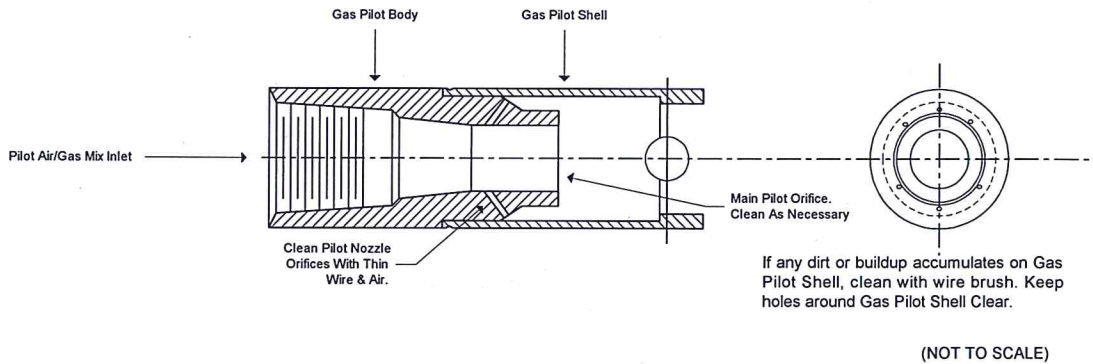
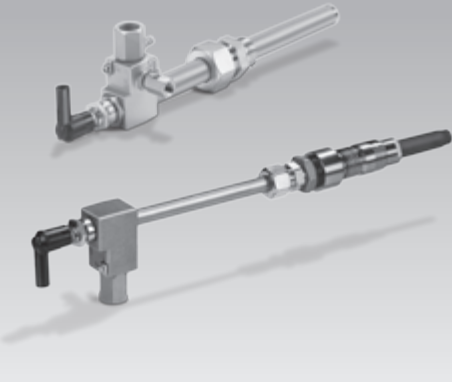

Figure 3. Cleaning Pilot Nozzle and Piloting Holes

Operating instructions Pilot burners ZMI, ZMIC



Contents

Pilot burners ZMI, ZMIC	1
Contents	1
Safety	1
Checking the usage	2
Checking the gas type	3
Installation	3
ZMIC	4
ZMIC..K	4
Wiring	4
Tightness test	4
Commissioning	5
ZMI	5
ZMIC	5
Maintenance	5
Replacing the electrodes	5
ZMIC..K: replacing the bellows unit	6
ZMIC: replacing the ceramic tube	7
Accessories	7
Technical data	7
Declaration of Incorporation	8
Contact	8

Safety

Please read and keep in a safe place



Please read through these instructions carefully before installing or operating. Following the installation, pass the instructions on to the operator. This unit must be installed and commissioned in accordance with the regulations and standards in force. These instructions can also be found at www.docuthek.com.

Explanation of symbols

■ **1, 2, 3...** = Action
 > = Instruction

Liability

We will not be held liable for damage resulting from non-observance of the instructions and non-compliant use.

Safety instructions

Information that is relevant for safety is indicated in the instructions as follows:

DANGER

Indicates potentially fatal situations.

WARNING

Indicates possible danger to life and limb.

! CAUTION

Indicates possible material damage.

All interventions may only be carried out by qualified gas technicians. Electrical interventions may only be carried out by qualified electricians.

Conversion, spare parts

All technical changes are prohibited. Only use OEM spare parts.

Transport

On receipt of the product, check that the delivery is complete (see Part designations). Report any transport damage immediately.

Storage

Store the product in a dry place. Ambient temperature: see Technical data.

Checking the usage

Intended use

ionization-controlled pilot burner for safely igniting gas burners. The capacity of the pilot burner should be 2 to 5% of that of the main burner.

Can also be used as independently operated burner. For natural gas, town gas, coke oven gas and LPG. Other types of gas on request.

This function is only guaranteed when used within the specified limits – see also page 7 (Technical data). Any other use is considered as non-compliant.

ZMI

Type code

Code	Description
ZMI	ionization pilot burner with forced air supply and one electrode
16–25	Burner size
T	T-product
B	For natural gas
G	For LPG
D	For town gas, coke oven gas
150–1000	Flame tube length
R	Rp internal thread
N	NPT internal thread

Part designations

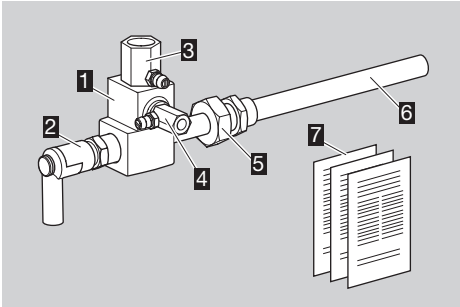

- 1 Burner housing
- 2 Interference-suppressed electrode plug
- 3 Air nozzle
- 4 Gas nozzle
- 5 Mounting device
- 6 Flame tube
- 7 Enclosed documentation: operating instructions and flow rate curves

Burner size, gas type, rated capacity P_{max} , flame tube length, connection – see type label.

D-49018 Osnabrück Germany		kromschroder
ZMI		
Gas	█	
Pmax.	█	

ZMIC

Type code

Code	Description
ZMIC	ionization pilot burner with forced air supply, one electrode and a ceramic flame tube tip
28	Burner size
B	For natural gas
G	For LPG
D	For town gas, coke oven gas
200–1000	Flame tube length
R	Rp internal thread
K	Bellows unit

Part designations

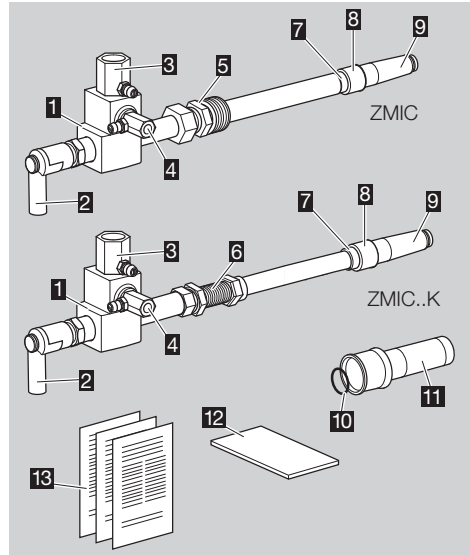

- 1 Burner housing
- 2 Interference-suppressed electrode plug
- 3 Air nozzle
- 4 Gas nozzle
- 5 Mounting device with reducing nipple
- 6 Bellows unit with nut
- 7 Ceramic tube retaining piece
- 8 Ceramic tube clamping ring
- 9 Ceramic tube
- 10 Rubber seal
- 11 Transport safety device (socket and double nipple)
- 12 Insulation strip
- 13 Enclosed documentation: operating instructions and flow rate curves

Burner size, gas type, rated capacity P_{max} , flame tube length, connection – see type label.

D-49018 Osnabrück Germany		kromschroder
ZMIC		
Gas	█	
Pmax.	█	

Checking the gas type

- 1 Check if the gas nozzle diameter is suitable for the required gas type.

Gas type	Nozzle dia. [mm (inch)]		
	ZMI 16	ZMI 25	ZMIC 28
B	0.94 (0.037)	1.40 (0.055)	1.40 (0.055)
G	0.76 (0.029)	1.05 (0.041)	1.05 (0.041)
D	1.30 (0.051)	1.78 (0.070)	1.78 (0.070)

- ▷ When changing the nozzle, remove the residue of sealant from the burner housing.
- ▷ Suitable nozzles – see page 7 (Accessories).

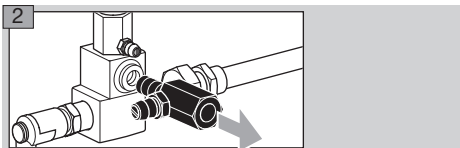

Installation

⚠ DANGER

Risk of explosion! Ensure the connection is gas-tight.

! CAUTION

Burner fault! If used as pilot burner, the gas and air pressures must be higher than the connection pressures of the main burner.

- ▷ Install the pilot burner so that reliable ignition of the main burner is guaranteed.
- ▷ Attach the pilot burner securely.
- ▷ We recommend that a filter be installed in the gas and air supply line respectively.
- ▷ Install pressure regulators and adjusting cocks in the air and gas supply lines upstream of the burner so that the air and gas pressures can be adjusted.

ZMI

- ▷ Recommended inlet pressures:
gas: up to 80 mbar (up to 32 "WC),
air: up to 120 mbar (up to 47 "WC).

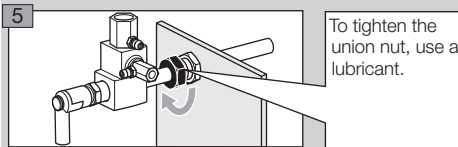
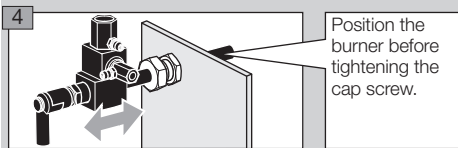
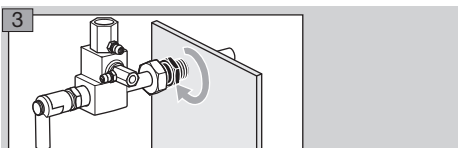
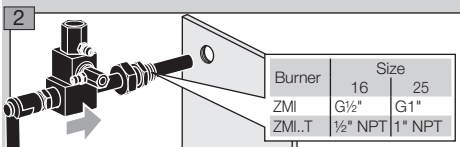
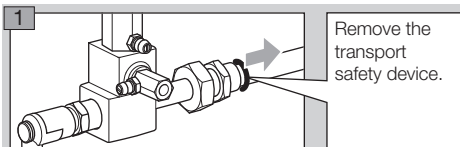

- 6 Hand tighten the union nut.
- 7 For gas-tight installation, tighten the union nut with a further turn.
- 8 Connect the pilot gas line with Rp ¼ and the air line with Rp ½.

ZMIC

- ▷ Recommended inlet pressures:
gas: up to 100 mbar (up to 40 "WC),
air: up to 120 mbar (up to 47 "WC).

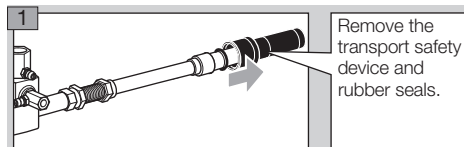

Insulating the ceramic tube

- ▷ Protect the ceramic tube from thermal stress.
 - ▷ Insulation with enclosed insulation strips.
- 2 Firmly secure the insulation strips to the ceramic tube using adhesive foil.
 - ▷ If the burner quarl is hot, wrap aluminium adhesive tape around the ceramic tube in addition to the adhesive foil to prevent the latter from cracking for as long as possible.

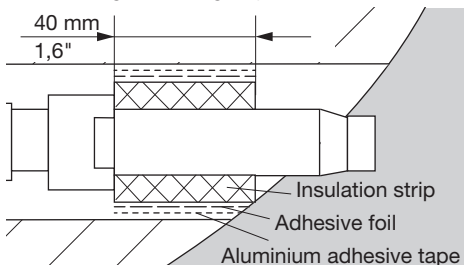

- 3 Check that the burner quarl hole is not blocked, e.g. using a wooden stick.

ZMIC

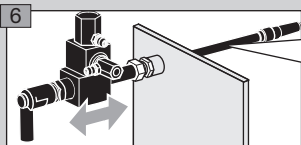
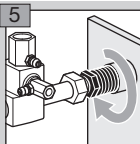
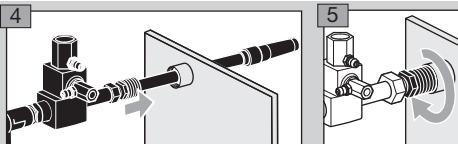

Position the burner before tightening the mounting device.

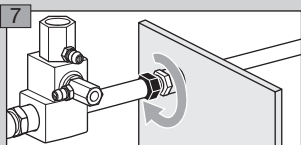

8 Follow the reverse procedure when dismantling.

ZMIC..K

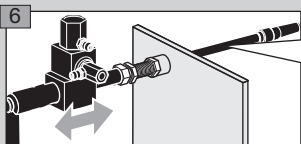
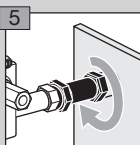
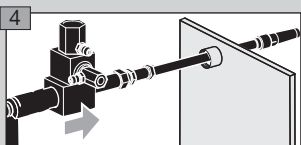

Position the burner before tightening the bellows unit nut.

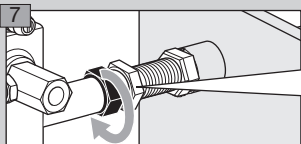

Secure the bellows unit here while tightening the bellows unit nut.

Wiring

⚠ DANGER

Electric shocks can be fatal! Before working on possible live components, ensure the unit is disconnected from the power supply.

- ▷ For the ionization and ignition cables, use un-screened high-voltage cable:
FZLSi 1/7 -50 to +180°C (-58 to +356°F),
Order No. 04250410,
or
FZLK 1/7 -5 to +80°C (23 to 176°F),
Order No. 04250409.
- ▷ Wire the burner as shown in the connection diagrams of the automatic burner control unit/ignition transformer.
- ▷ Flame control and ignition by a single electrode (single-electrode operation).

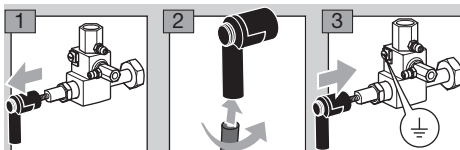

4 Route the PE wire directly to the automatic burner control unit.

Tightness test

⚠ DANGER

Risk of explosion and poisoning! To ensure that there is no danger resulting from a leak, check the gas connections on the burner for leaks immediately after the burner has been put into operation.

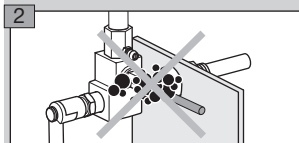
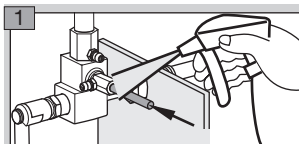

Commissioning

⚠ DANGER

Risk of explosion! Please observe the appropriate precautions when igniting the burners.

Risk of poisoning! Open the gas and air supply so that the burner is always operated with excess air – otherwise CO will form in the furnace chamber. CO is odourless and poisonous! Conduct a flue gas analysis.

- ▷ Arrange the adjustment and commissioning of the burner with the system operator or manufacturer.
- ▷ Check the entire system, upstream devices and electrical connections.
- ▷ Pre-purge the furnace chamber with air (5 x furnace chamber volume) before every ignition attempt.

⚠ DANGER

Risk of explosion! Fill the gas line to the burner carefully and correctly with gas and vent it safely into the open air – do not discharge the test volume into the furnace chamber.

- ▷ If the burner does not ignite although the automatic burner control unit has been switched on and off several times: check the entire system.
 - ▷ After ignition, monitor the gas and air pressures measured on the burner and the flame. Measure the ionization current. Switch-off threshold – see automatic burner control unit operating instructions.
- 1 Switch on the system.
 - 2 Open the manual valve.
 - 3 Ignite the burner via the automatic burner control unit.
 - 4 Adjust the burner.
- ▷ Set the ionization current by adjusting the air volume.
 - ▷ The ionization current must be at least 5 µA and must not vary.

⚠ DANGER

Risk of explosion in case of CO being formed in the furnace chamber! An incorrect change of the burner settings may change the gas/air ratio and lead to unsafe operating conditions. CO is odourless and poisonous!

- 5 Set the pressure regulators for the gas and air supply pressures to the maximum admissible values, whereby the gas and air supply pressures should be identical.

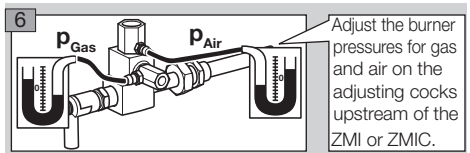

- ▷ The air inlet pressure should be higher than the gas inlet pressure: operating characteristic diagrams – see www.docuthek.com.

ZMI

- ▷ Inlet pressure:
 - gas: up to 80 mbar (up to 32 "WC),
 - air: up to 120 mbar (up to 47 "WC).

ZMIC

- ▷ Inlet pressure:
 - gas: up to 80 mbar (up to 32 "WC),
 - air: up to 120 mbar (up to 47 "WC).

Maintenance

- ▷ We recommend an annual function check.

⚠ DANGER

Electric shocks can be fatal! Before working on possible live components, ensure the unit is disconnected from the power supply.

Risk of burning! Dismantled burner components can be hot due to outflowing flue gases.

Risk of explosion and poisoning in case of burner adjustment with an air deficiency! Adjust the gas and air supply so that the burner is always operated with excess air – otherwise CO will form in the furnace chamber. CO is odourless and poisonous! Conduct a flue gas analysis.

- 1 Check the ionization and ignition cables.
 - 2 Measure the ionization current.
- ▷ The ionization current must be at least 5 µA and must not vary.
- 3 Disconnect the system from the electrical power supply.
 - 4 Shut off the gas and air supply – do not change the restrictor settings.
 - 5 Check the nozzles for dirt.

Replacing the electrode

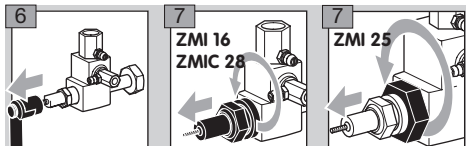

- ▷ Ensure that the electrode length does not change.

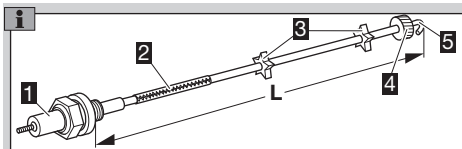

- 1 Spark plug
- 2 Dowel pin
- 3 Insulators
- 4 Burner head
- 5 Electrode tip

- 8 Remove dirt from electrode and insulators.
- 9 If the electrode tip or insulators are damaged, replace the electrode.
 - ▷ Before changing the electrode, measure the total length **L**.
- 10 Connect the new electrode with the spark plug using the dowel pin.
- 11 Adjust spark plug and electrode to the measured total length **L**.
- 12 Screw the electrode into the burner housing.
- 13 Check distance **L2**:

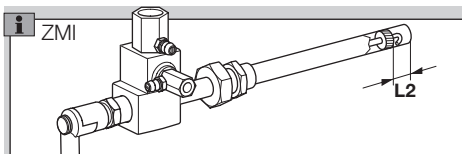

Burner	L2	Burner	L2
ZMI 16B	25 mm	ZMI 25B	35 mm
ZMI 16D	21 mm	ZMI 25D	20 mm
ZMI 16G	25 mm	ZMI 25G	35 mm

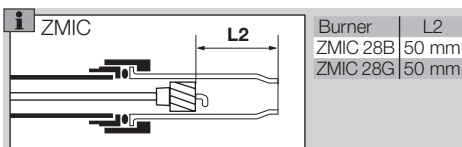

Burner	L2
ZMIC 28B	50 mm
ZMIC 28G	50 mm

- Reconnect the electrode plug.
- Produce a maintenance report.

ZMIC..K: replacing the bellows unit

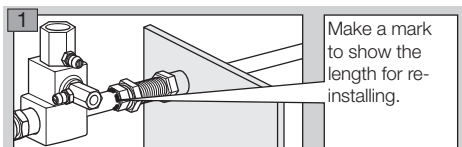

Make a mark to show the length for re-installing.

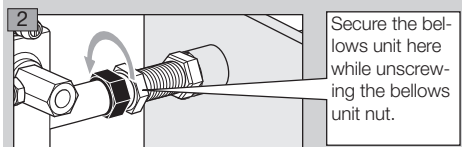

Secure the bellows unit here while unscrewing the bellows unit nut.

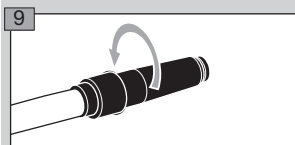
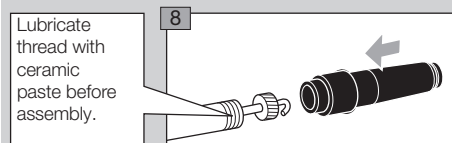
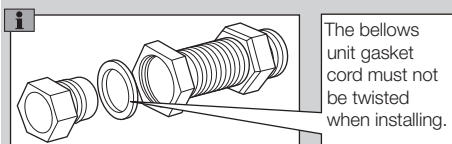
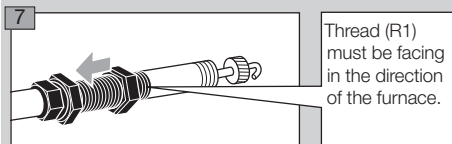
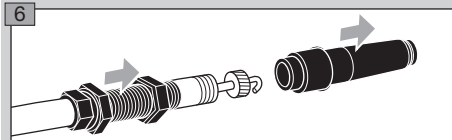
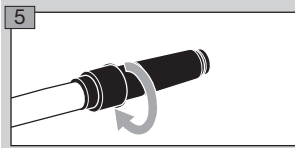
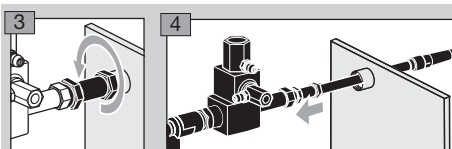

- 10 Insulate the ceramic tube and re-install the burner, see page 3 (Installation).

ZMIC: replacing the ceramic tube

- 1 Remove the ZMIC – see page 6 (ZMIC..K: replacing the bellows unit).

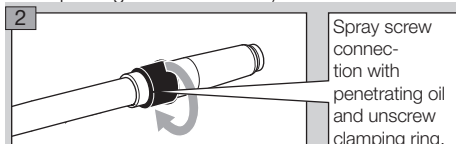

Spray screw connection with penetrating oil and unscrew clamping ring.

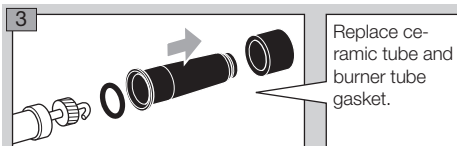

Replace ceramic tube and burner tube gasket.

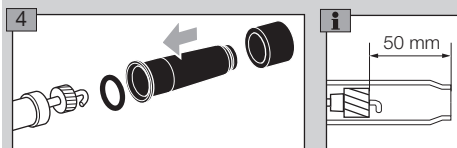

50 mm

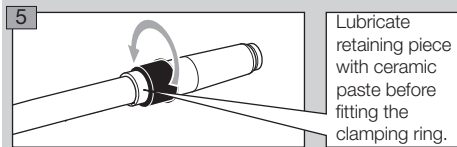

Lubricate retaining piece with ceramic paste before fitting the clamping ring.

- 6** Insulate the ceramic tube.
7 Re-install the burner, see page 3 (Installation).

Ceramic paste

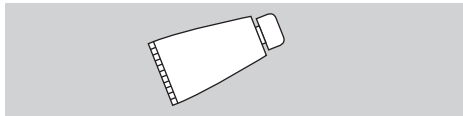

Apply ceramic paste to the screw connections after replacing any burner components in order to avoid cold-setting.

Order number: 05012009.

Technical data

ZMI

Capacity:

ZMI 16: 1 to 2 kW (3.8 to 7.6 10³ BTU/h),
 ZMI 25: 2.5 to 4 kW (9.5 to 15.1 10³ BTU/h)
 (1.5 to 3.3 kW in conjunction with town gas, coke oven gas).

Capacities in kW refer to the lower calorific value H_L and capacities in BTU/h refer to the upper calorific value H_U.

Gas inlet pressure: 15 to 70 mbar (6 to 27 "WC),
 air inlet pressure: 15 to 90 mbar (6 to 35 "WC),
 each depending on the gas type
 (burner pressures – see www.docuthek.com,
 Kind of document: Flow rate curve).

Burner length increments: 100 mm (4").

Gas types: natural gas, LPG (gaseous) and coke oven gas; other types of gas on request.

For cold air only.

Flame control: with ionization electrode.

Ignition: direct spark ignition (5 kV ignition transformer).

Angle plug: interference-suppressed.

Housing: aluminium.

Flame tube: heat-resistant steel.

Max. temperature at the tip of the flame tube:

< 1000°C (< 1832°F),

< 900°C (< 1652°F) for lambda < 1.

ZMIC

Capacity:

2.5 to 4.2 kW (9.5 to 15.9 10³ BTU/h).

Capacities in kW refer to the lower calorific value H_L and capacities in BTU/h refer to the upper calorific value H_U.

Gas inlet pressure: up to 100 mbar (up to 40 "WC),
 air inlet pressure: up to 120 mbar (up to 47 "WC),
 each depending on the gas type
 (burner pressures – see www.docuthek.com,
 Kind of document: Flow rate curve).

Burner length increments: 100 mm (4"),
 length increments of the ZMIC 28..K: 50 mm (2").
 Gas types: natural gas, LPG (gaseous) and coke oven gas; other types of gas on request.

Accessories

Gas nozzle

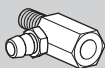

Burner	Gas type*	mm (inch)	Order No.	
			ZMI/ZMIC	ZMI..T
ZMI 16	B	0.94 (0.037)	75455010	75442157
	G	0.76 (0.029)	75455147	75448032
	D	1.30 (0.051)	75455146	–
ZMI 25	B	1.40 (0.055)	75455012	75443157
	G	1.05 (0.041)	75455149	75448031
	D	1.78 (0.070)	75455148	–
ZMIC 28	B	1.40 (0.055)	75455012	–
	G	1.05 (0.041)	75455149	–
	D	1.78 (0.070)	75455148	–

* B = Natural gas

G = LPG

D = Town gas/coke oven gas

For cold air only.
 Flame control: with ionization electrode.
 Ignition: direct spark ignition (5 kV ignition transformer).
 Ignition electrode plug: interference-suppressed.
 Housing: aluminium.
 Flame tube: ceramic flame tube.
 Max. temperature at the tip of the flame tube:
 1450°C (2642°F).



Einbauerklärung / **Declaration of Incorporation**
 nach 2006/42/EG, Anhang II, Nr. 1B / according to 2006/42/EC, Annex II No. 1B

Folgendes Produkt / The following product:
 Bezeichnung: Brenner für Gas
 Description: Burner for gas
 Typenbezeichnung / Type: ZAL, ZMI, ZMIC, ZKIH

ist eine unvollständige Maschine nach Artikel 2g und ausschließlich zum Einbau in oder zum Zusammenbau mit einer anderen Maschine oder Ausrüstung vorgesehen.
 is a partly completed machine pursuant to Article 2g and is designed exclusively for installation in or assembly with another machine or other equipment.

Folgende grundlegende Sicherheits- und Gesundheitsschutzanforderungen gemäß Anhang I dieser Richtlinie kommen zur Anwendung und wurden eingehalten.
 The following essential health and safety requirements in accordance with Annex I of this Directive are applicable and have been fulfilled.

Anhang I, Artikel / Annex I, Article
 1.1.3, 1.1.5, 1.3.2, 1.5.2, 1.7.4

Die speziellen technischen Unterlagen gemäß Anhang VII B wurden erstellt und werden der zuständigen nationalen Behörde auf Verlangen in elektronischer Form überreicht.
 The relevant technical documentation has been compiled in accordance with part B of Annex VII and will be sent to the relevant national authorities on request as a digital file.

Folgende (harmonisierte) Normen wurden angewandt: / The following (harmonized) standards have been applied
 EN 746-2 (2010) - Industrielle Thermoprocessinganlagen, Sicherheitsanforderungen an Feuerungen und Brennstoffführungssysteme
 - Industrial thermoprocessing equipment, Safety requirements for combustion and fuel handling systems
 EN ISO 12100 (2010): Sicherheit von Maschinen - Grundlegende allg. Gestaltungsgrundsätze
 - Safety of machinery - Basic concepts, general principles for design

Die unvollständige Maschine darf erst dann in Betrieb genommen werden, wenn festgestellt wurde, dass die Maschine, in der das oben beschriebene Produkt eingesetzt werden soll, den Bestimmungen der Richtlinie für Maschinen (2006/42/EG) entspricht.
 The partly completed machine may only be commissioned once it has been established that the machine into which the product mentioned above should be incorporated complies with the provisions of the Machinery Directive 2006/42/EC.

Lotte (Büren)
 15.10.2013
 Datum / Date

S. Rundo, L. Schröder
 Sandra Rundo, Lars Schröder
 Konstrukteure / Designers

Elster GmbH
 Postfach 28 09
 D-49018 Osnabrück
 Strothweg 1
 D-49504 Lotte (Büren)
 Tel: +49 (0)541 12 14-0
 Fax: +49 (0)541 12 14-370
 info@kromschroeder.com
 www.kromschroeder.com

Sandra Rundo, Lars Schröder sind bevollmächtigt, die speziellen technischen Unterlagen gemäß Anhang VII B zusammenzustellen.
 Sandra Rundo, Lars Schröder are authorized to compile the relevant technical documentation according to Annex VII B.

Declaration of Incorporation

pursuant to 2006/42/EC, Annex II, No. 1B
 The products "Burners for gas ZMI and ZMIC" are partly completed machines pursuant to Article 2g which are designed exclusively for installation in or assembly with another machine or other equipment. The following essential health and safety requirements pursuant to Annex I of this Directive have been applied and satisfied:
 Annex I, Articles 1.1.3, 1.1.5, 1.3.2, 1.5.2, 1.7.4
 The relevant technical documentation pursuant to Annex VII B has been produced and will be transmitted to the competent national authorities in electronic form on request.
 The following (harmonized) standards have been applied:

- EN 746-2 (2010) - Industrial thermoprocessing equipment - Safety requirements for combustion and fuel handling systems
- EN ISO 12100 (2010) - Safety of machinery - General principles for design - Risk assessment and risk reduction (ISO 12100:2010)

The partly completed machine may only be commissioned once it has been established that the machine where the product mentioned above is to be incorporated complies with the provisions of the Machinery Directive 2006/42/EC.
 Elster GmbH

Contact

If you have any technical questions, please contact your local branch office/agent. The addresses are available on the Internet or from Elster GmbH.

We reserve the right to make technical modifications in the interests of progress.

elster
 Kromschroder

Elster GmbH
 Postfach 28 09, D-49018 Osnabrück
 Strothweg 1, D-49504 Lotte (Büren)
 T +49 541 1214-0
 F +49 541 1214-370
 info@kromschroeder.com, www.kromschroeder.com