

Operating instructions
Pressure gauges KFM, RFM
Manual cock DH
Pressure gauge shut-off valve
MH 15
Positive pressure protection UDS



Contents

Pressure gauges KFM, RFM
Manual cock DH
Pressure gauge shut-off valve MH 15
Positive pressure protection UDS 1
Contents 1
Safety 1
Checking the usage 2
 Intended use 2
Installation 3
 Setting the lock-up pressure on the UDS. 3
 Venting on the MH 3
 Venting on the RFM..100 3
 Zero point correction 3
Tightness test 4
Maintenance 4
Accessories 4
Technical data 4
 KFM, RFM 4
 DH, MH 15 4
 UDS 5
 Designed lifetime 5
Logistics 5
Certification 5
 Declaration of conformity 5
 Eurasian Customs Union 5
Contact 6

Safety

Please read and keep in a safe place



Please read through these instructions carefully before installing or operating. Following the installation, pass the instructions on to the operator. This unit must be installed and commissioned in accordance with the regulations and standards in force. These instructions can also be found at www.docuthek.com.

Explanation of symbols

■, **1**, **2**, **3**... = Action
 > = Instruction

Liability

We will not be held liable for damage resulting from non-observance of the instructions and non-compliant use.

Safety instructions

Information that is relevant for safety is indicated in the instructions as follows:

⚠ DANGER

Indicates potentially fatal situations.

⚠ WARNING

Indicates possible danger to life and limb.

! CAUTION

Indicates possible material damage.

All interventions may only be carried out by qualified gas technicians. Electrical interventions may only be carried out by qualified electricians.

Conversion, spare parts

All technical changes are prohibited. Only use OEM spare parts.

Changes to edition 04.17

The following chapters have been changed:

- Installation
- Certification

Checking the usage

Intended use

KFM, RFM

Pressure gauge with capsule element KFM, in accordance with EN 837, Part 3, and pressure gauge with Bourdon tube RFM, in accordance with EN 837, Part 1, for indication of static gas and air pressures. Pressure gauge with Bourdon tube RFM..100 (scale diameter 100 mm), in accordance with EN 837, Part 2, with discharge bore on the housing rear side. The pressure gauges may be used only for indication and may not be used as a part of a safety device for protection against exceeding permitted limits (safety accessories).

DH, MH 15

The pressure gauge is protected against pressure fluctuations provided that the manual cock DH and the pressure gauge shut-off valve MH remain closed.

UDS

The positive pressure protection UDS closes and protects the pressure gauge against damage as soon as excess pressures exceed the set lock-up pressure on the UDS.

This function is only guaranteed when used within the specified limits – see page 4 (Technical data). Any other use is considered as non-compliant.

Code	Description
KFM	Pressure gauge with capsule element
RFM	Pressure gauge with Bourdon tube
	KFM measuring range:
20	-20 to +20 bar
25	0 to 25 mbar
40	0 to 40 mbar
60	0 to 60 mbar
100	0 to 100 mbar
160	0 to 160 mbar
250	0 to 250 mbar
400	0 to 400 mbar
2500	0 to 2500 Pa
	RFM measuring range:
0,6	0 to 0,6 bar
1,6	0 to 1,6 bar
4	0 to 4 bar
6	0 to 6 bar
10	0 to 10 bar
16	0 to 16 bar
	KFM measuring range [psi]:
P0,6	0 to 0,6 psi
P1,0	0 to 1,0 psi
P1,6	0 to 1,6 psi
P2,5	0 to 2,5 psi
P4,0	0 to 4,0 psi
P5,0	0 to 5,0 psi
	RFM measuring range [psi]:
P10	0 to 10 psi
P23	0 to 23 psi
P60	0 to 60 psi
P150	0 to 150 psi
P230	0 to 230 psi
T	T-product
R	Connection pin with cylindrical pipe thread
N	NPT external thread
B	Positive pressure
U	Positive and negative pressure
63	63 mm visible scale diameter
100	100 mm visible scale diameter

Part designations

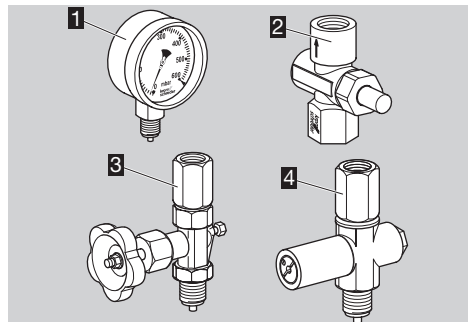

- 1** KFM, RFM
- 2** Manual cock DH
- 3** Pressure gauge shut-off valve MH 15
- 4** Positive pressure protection UDS

Installation

! CAUTION

Please observe the following to ensure that the unit is not damaged during installation and operation:

- Mount the pressure gauge in a location not subject to vibration and so as to provide easy read-off. Parallax error during read-off must be avoided.
- Use approved sealing material only.
- Sealing material and dirt, e.g. thread cuttings, must not be allowed to get into the housing.
- Do not use the pressure gauge as a lever during installation and removal – use appropriate spanners.
- Dropping the device can cause permanent damage. In this event, replace the entire device and associated modules before use.

- ▷ Installation in the vertical position.



- ▷ Note wall clearance and turning radius – min. 60 mm (2.36").
- ▷ Note the flow direction on the manual cock DH and the positive pressure protection UDS.



- ▷ Fit a copper seal between pressure gauge and manual cock or pressure gauge shut-off valve, see page 4 (Accessories).

Setting the lock-up pressure on the UDS

- ▷ The positive pressure protection UDS is set to the adjusting range mid-point at the works.

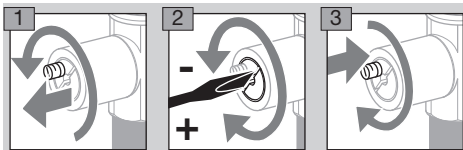

Venting on the MH

⚠ WARNING

When releasing the pressure, ensure that no-one is put at risk from the escaping medium.

When setting the pressure gauge to zero, the confined pressure between the valve and pressure gauge must first be released using the vent screw.

- 1 Close the valve before opening the vent screw.

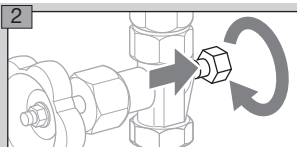

Venting on the RFM..100

- ▷ To avoid pressure building up outside of the pressure gauge with Bourdon tube, cut off the nipple on the filler plug.

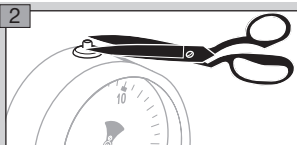

Zero point correction

⚠ WARNING

Apply pressure slowly to measuring instruments. Open the upstream shut-off valve slowly. Avoid pressure surges and temperature fluctuations.

- ▷ If the bayonet ring cannot be unscrewed easily from the housing, use a belt spanner.

KFM

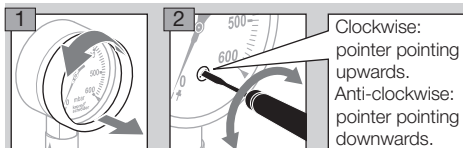

RFM

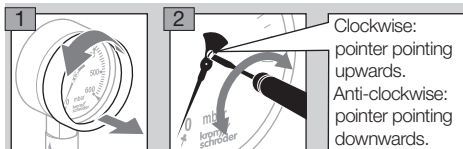

Tightness test

- ▷ The test pressure may not exceed the full scale value of the pressure gauge.
- 1** Pressurize the pressure gauge carefully.
- ▷ DH: press push-button.
- ▷ MH, UDS: slowly turn the hand wheel anti-clockwise.

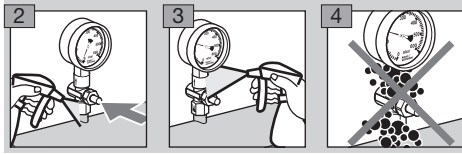

Maintenance

- ▷ Pressure gauges, manual cock, pressure gauge shut-off valve and positive pressure protection require no maintenance.
- ▷ An annual function check, including check of the indicated pressure, is recommended.
- ▷ Repairs may be carried out only by the manufacturer.
- ▷ Relieve the pressure before removing the pressure gauge.

Accessories

Pressure gauge seal

A seal must be inserted between the pressure gauge and manual cock DH or pressure gauge shut-off valve MH.

¼" connection, Cu: Order No. 03110617,
 ½" connection, Cu: Order No. 03110615,
 biogas, ½" connection, PTFE: Order No.
 03110711.

Technical data

KFM, RFM

For natural gas, town gas, LPG (gaseous) and air.

Ambient temperature:

-20 to +60°C (-4 to +140°F).

Measuring range: see pressure gauge.

IP 54: KFM..100, RFM..100,

IP 32: KFM..63, RFM..63.

Threaded connection:

Type	Brass connection	EN 837	A/F
KFM..100	G ½ B	Part 3	A/F 22
KFM..63	G ¼ B	Part 3	A/F 14
RFM..100	G ½ B	Part 1	A/F 22
RFM..63	G ¼ B	Part 1	A/F 14

Scope of application in accordance with EN 837-2: The medium pressure to be measured may exceed the full scale value of the pressure gauge only as the result of brief pressure surges.

Type	Steady state	Load type	
		Alternating	Brief-duration
KFM, RFM	0.75 x full scale value	0.67 x full scale value	1.3 x full scale value

Indicating accuracy:

Type	Class	Indicating error
		(standard temp. + 20°C (68°F))
KFM	1.6	± 0.6% of full scale value per 10°C (50°F) temperature fluctuation
RFM	1.0	± 0.4% of full scale value per 10°C (50°F) temperature fluctuation

DH, MH 15

For natural gas, town gas, LPG (gaseous) and air.

MH..M: biogas.

Ambient temperature:

DH: -20 to +60°C (-4 to +140°F),

MH: -10 to +70°C (50 to 158°F).

Max. inlet pressure p_U :

DH: 5 bar (72.5 psi),

MH: 100 bar (1450 psi).

Connection:

DH 8R50: Rp ¼,

DH 15R50: Rp ½,

MH 15: G ½, DIN ISO 228, Part 1.

DH 8R50, Rp ¼: Order No. 03152141,

DH 15R50, Rp ½: Order No. 03152149.

MH 15, G ½: Order No. 03150191,

MH 15M, G ½, for aggressive media:

Order No. 03150192.

UDS

For natural gas, town gas, LPG (gaseous) and air.

UDS..M: biogas.

Ambient temperature:

UDS: -10 to +60°C (50 to 140°F).

Connection: G ½, DIN ISO 228, Part 1.

Max. inlet pressure p_{U_i}	Adjusting range
2.5 bar (36.3 psi)	0.4–2.5 bar (5.8–36.3 psi)
6 bar (87 psi)	2–6 bar (29–87 psi)
25 bar (363 psi)	5–25 bar (72.5–363 psi)

UDS 2,5: Order No. 03150621,

UDS 6,0: Order No. 03150623,

UDS 25: Order No. 03150625.

For aggressive media:

UDS 2,5M: Order No. 03150622,

UDS 6,0M: Order No. 03150624,

UDS 25M: Order No. 03150626.

The UDS is set to the adjusting range mid-point at the works.

Storage temperature (for all):

-20 to +40°C (-4 to +104°F).

Designed lifetime

This information on the designed lifetime is based on using the product in accordance with these operating instructions. Once the designed lifetime has been reached, safety-relevant products must be replaced. Designed lifetime (based on date of manufacture): 10 years.

You can find further explanations in the applicable rules and regulations and on the afecor website (www.afecor.org).

This procedure applies to heating systems. For thermoprocessing equipment, observe local regulations.

Logistics

Transport

Protect the unit from external forces (blows, shocks, vibration). On receipt of the product, check that the delivery is complete, see page 2 (Part designations). Report any transport damage immediately.

Storage

Store the product in a dry and clean place.

Storage temperature: see page 4 (Technical data).

Storage time: 6 months before using for the first time. If stored for longer than this, the overall service life will be reduced by the corresponding amount of extra storage time.

Packaging

The packaging material is to be disposed of in accordance with local regulations.

Disposal

Components are to be disposed of separately in accordance with local regulations.

Certification

Declaration of conformity

DH



We, the manufacturer, hereby declare that the product DH with product ID No. CE-0085AR0464 complies with the requirements of the listed Acts and Standards.

Regulation:

– (EU) 2016/426 – GAR

Standard:

– DVGW VP 308:2004

The relevant product corresponds to the tested type sample.

The production is subject to the surveillance procedure pursuant to Regulation (EU) 2016/426 Annex III, Module C2.

Elster GmbH

Scan of the Declaration of conformity (D, GB) – see www.docuthek.com

Eurasian Customs Union



The products DH, MH 15 and UDS meet the technical specifications of the Eurasian Customs Union.

The products KFM and RFM hold a metrological certificate in accordance with the Russian standard.

The product KFM holds a metrological certificate in accordance with the Belorussian standard.

Contact

If you have any technical questions, please contact your local branch office/agent. The addresses are available on the Internet or from Elster GmbH.

We reserve the right to make technical modifications in the interests of progress.

Honeywell

**krom//
schroder**

Elster GmbH
Strotheweg 1, D-49504 Lotte (Büren)

Tel. +49 541 1214-0

Fax +49 541 1214-370

hts.lotte@honeywell.com, www.kromschroeder.com