

Eclipse Multi-Flame Multiple Burner Monitoring System

Model 6000

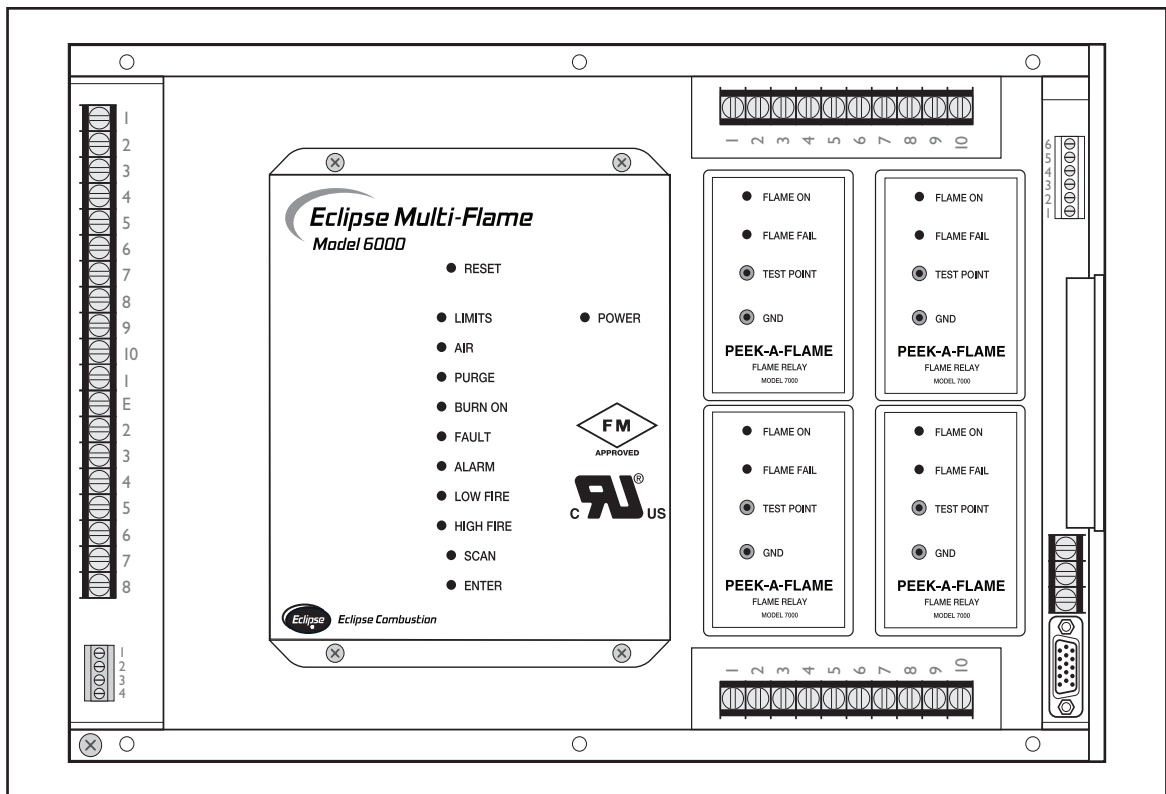

COPYRIGHT

Copyright 2007 by Eclipse, Inc. All rights reserved worldwide. This publication is protected by federal regulation and shall not be copied, distributed, transmitted, transcribed or translated into any human or computer language, in any form or by any means, to any third parties, without the express written consent of Eclipse, Inc.

In accordance with the manufacture's policy of continual product improvement, the product presented in this brochure is subject to change without notice or obligation.

DISCLAIMER NOTICE

The material in this manual is believed adequate for the intended use of the product. If the product is used for purposes other than those specified herein, confirmation of validity and suitability must be obtained. Eclipse warrants that the product itself does not infringe upon any United States patents. No further warranty is expressed or implied.

We have made every effort to make this manual as accurate and complete as possible. Should you find errors or omissions, please bring them to our attention so that we may correct them. In this way we hope to improve our product documentation for the benefit of our customers. Please send your corrections and comments to our Marketing Communications Manager.

LIABILITY AND WARRANTY

It must be understood that Eclipse's liability for its product, whether due to breach of warranty, negligence, strict liability, or otherwise is limited to the furnishing of replacement parts and Eclipse will not be liable for any other injury, loss, damage or expenses, whether direct or consequential, including but not limited to loss of use, income, or damage to material arising in connection with the sale, installation, use of, inability to use, or the repair or replacement of Eclipse's products.

Any operation expressly prohibited in this Guide, any adjustment, or assembly procedures not recommended or authorized in these instructions shall void the warranty.

About this manual

AUDIENCE

This manual has been written for the people who select and install the product and the technicians who work on it. They are expected to have previous experience with this kind of equipment.

IMPORTANT NOTICES

Read this manual carefully. Make sure that you understand the structure and contents of this manual.

- Obey all the safety instructions.
- Do not deviate from any instructions or application limits in this manual without written consent from Eclipse.
- If you do not understand any part of the information in this manual, do not continue. Contact Eclipse.

DOCUMENT CONVENTIONS

There are several special symbols in this document. You must know their meaning and importance.

The explanation of these symbols follows. Please read it thoroughly.



Danger:

Indicates hazards or unsafe practices which WILL result in severe personal injury or even death. Only qualified and well trained personnel are allowed to carry out these instructions or procedures.

Act with great care and follow the instructions.



Warning:

Indicates hazards or unsafe practices which could result in severe personal injury or damage. Act with great care and follow the instructions.



Caution:

Indicates hazards or unsafe practices which could result in damage to the machine or minor personal injury. Act carefully.



Note:

Indicates an important part of the text. Read the text thoroughly.



Table of Contents

1	Introduction	7
	Product Description	7
2	Specifications	8
	Introduction	8
	Specifications	8
	Dimensions	9
3	Modules Description	10
	Introduction	10
	Module Description and Identification	10
4	DIP Switch Selection	12
	Introduction	12
	DIP Switch Location	12
	DIP Switch Access	12
	DIP Switch Settings	13
5	Function Summary	14
	Introduction	14
	Combustion Air Flow Check Terminal	14
	Main Fuel Valve Proof-of-Closure Terminal	14
	Low Fire Start Terminal	14
	High Fire/High Fire Purge Check Terminal	14
	Recycle Mode	15
	Pilot Test Mode	15
	Interrupted or Intermittent Pilot	15
	Spark, Pilot Flame and Main Flame Separation	15
	Auxiliary Inputs	16
	History Log	16
	Modulation Contacts	17
	Valve Leak Sensing Device Interface	18
	Remote Display Unit	19
	Communication Interfaces	19
	Logic Module Status Lights & Push Buttons	19
	Logic Module	20
	System Faults	21
	System Lockout Conditions	21
6	System Installation	22
	Introduction	22
	Interlocks and Limit Switch Input	22
	Combustion Air Switch Input	22
	Ignition wiring	23
	Communication wiring	23
	Power supply	23

	Low fire position input	23
	Main valve	23
	proof-of-closure	23
	High Fire Position Input.....	24
	Auxiliary Inputs	24
	Remote Reset	24
	Expansion Boards.....	24
	Figure 6.1 Terminal Strips Identification & Location	25
	Expansion Boards(Continued)	25
	Remote Display	25
	Figure 6.2 Wiring Diagram & Connections–Main Chassis...26	
	Figure 6.3 Wiring Diagram & Connections–Expansion Board for up to Four Burners	27
	Figure 6.4 Wiring Diagram & Connections–Expansion Board for up to Eight Burners.....	28
7	Sensor Installation	29
	Introduction	29
	Sensor Wiring	29
	Flame Rods	30
	Scanners	30
	Scanner Sighting Conditions.....	31
8	Test Procedures.....	32
	Introduction	32
	Flame Signal Strength	32
	Minimum Pilot Test.....	32
	Pilot flame failure test	33
	Main flame failure test For Interrupted Pilot Systems	33
	Spark sighting test.....	33
	Limits and interlock tests.....	33
9	Maintenance & Troubleshooting	34
	Introduction	34
	Maintenance	34
	Monthly Checklist.....	34
	Yearly Checklist.....	35
	Troubleshooting.....	36
10	Remote Display Messages	37
	Introduction	37
	Table 10.1 Multi-Flame Operating Sequence.....	38
	Table 10.2 Remote Display Diagnostic Messages	42
11	Appendix	45
	Conversion Factors	45
	Purge Time Example	46
	ASCII Text String Example	46
	Timing Sequence	47
	Illustrated Parts List.....	48

Introduction

1

PRODUCT DESCRIPTION

The Eclipse Multi-Flame Burner Monitoring System controls the startup sequence and monitors the flame of up to 20 individual gas, oil, or combination gas/oil burners connected to a common valve train. Its dynamic on-board testing checks for faulty relays, proof of valve closure, high and low fire switch interlocks, and shorted air switch.

The microcomputer-based system features a plug-in modular design so any of the circuit board modules attached to the motherboard can be replaced when power is removed. Its DIP switches allow sequence and timing functions, as well as system configuration. It is also capable of modulation (high and low fire purging) and monitoring up to four auxiliary inputs, history logging, and interfacing to valve leakage detection devices. It is UL-recognized for the U.S.A. and Canada and FM-approved.

Figure 1.1 Multi-Flame Burner Monitoring System

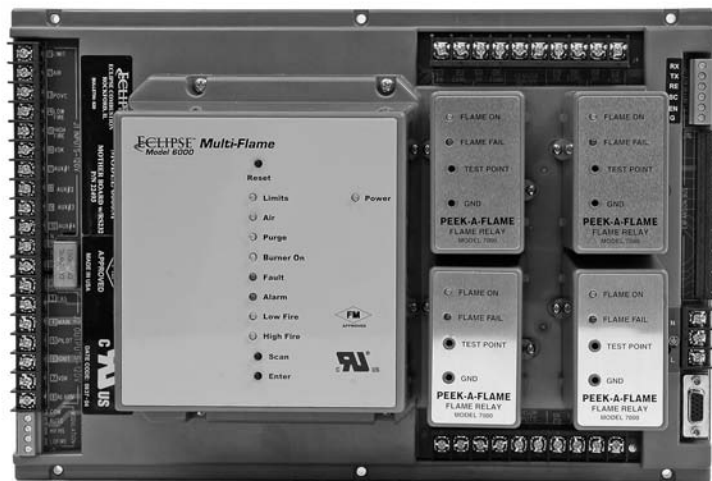

Specifications

2

INTRODUCTION

This section gives a detailed overview of Multi-Flame specifications and dimensions.

SPECIFICATIONS

Parameter	Description			
Supply	<ul style="list-style-type: none"> 120 VAC (+10%, -15%), 50/60 Hz standard. Internal power consumption: 30 VA per motherboard+3VA per burner 			
Temperature Ranges	Unit	Model Nos	Temperature Range	
	Multi-Flame	6000	-40° to +60°C (-40° to +140°F)	
	Peek-A-Flame	7000	-40° to +60°C (-40° to +140°F)	
	90° U.V. Scanner	5600-90A	-20° to +60°C (0° to 140°F)	
	U.V. Scanner	5600-91	-20° to +125°C (0° to +257°F)	
	NEMA4 UV Scanner	5600-91N4	-20° to +125°C (0° to 257°F)	
	Self-Check U.V.	5602-91	-20° to +60°C (0° to +140°F)	
	Remote Display	6000D	0° to 50°C (32° to 122°F)	
Flame Filure Response	<ul style="list-style-type: none"> 3 Seconds ± 0.5 seconds. 			
TFI/Pilot Interrupt	<ul style="list-style-type: none"> 5, 10, or 15 seconds selectable. 			
Purge Time	<ul style="list-style-type: none"> Moldulating, selectable from 0-225 seconds in 15 second increments, or 0-15 minutes in 1-minute increments. Process: selectable from 0-15 minutes in 1-minute increments, or 0-60 minutes in 4-minute increments. 			
Contact Ratings @ 120VAC (Maximum total connected load not to exceed 15 amps*)	Function	Effected Terminals	Inductive Load	Resistive Load
	Output Relay	J2-4 through J2-8	1/3 HP	10 amps
	Fan Motor	J2-3	1/2 HP	15 amps
	Modulation	J3-1 through J3-4	1/3 HP	10 amps
Approvals	<ul style="list-style-type: none"> UL Recognized for Canada and U.S.; File MPI537 FM Approved; File 3013812 			
U.S. Patent	<ul style="list-style-type: none"> Number Issued: 5,549,469 Date Issued: August 27, 1996 			
Shipping Weight	<ul style="list-style-type: none"> 3.3 Kilograms (7.3 lbs) for four burner unit. 			

*Resistive loads have inrush currents approximately the same as steady state operation. The inductive inrush current must be less than 10 times the rating. The inrush current must not be applied more than once every 15 seconds

DIMENSIONS

Main Chassis (For two to four burners)

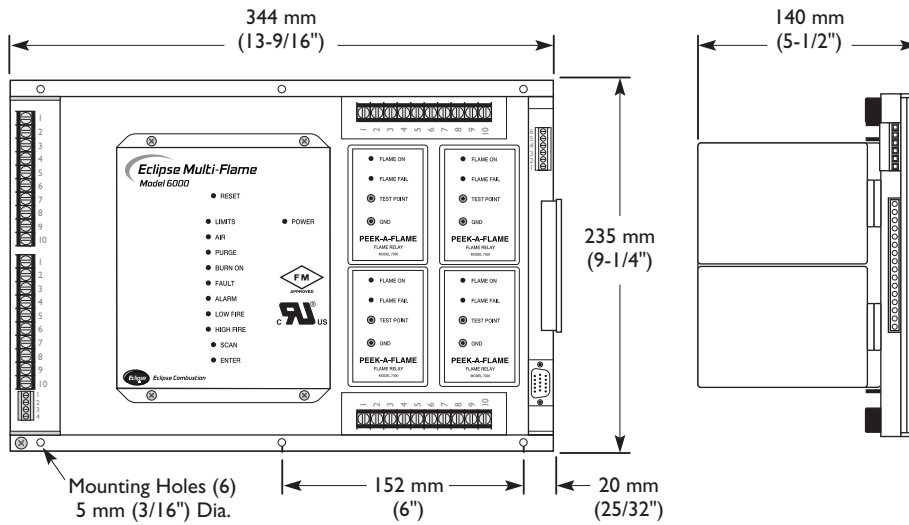

Expansion Boards

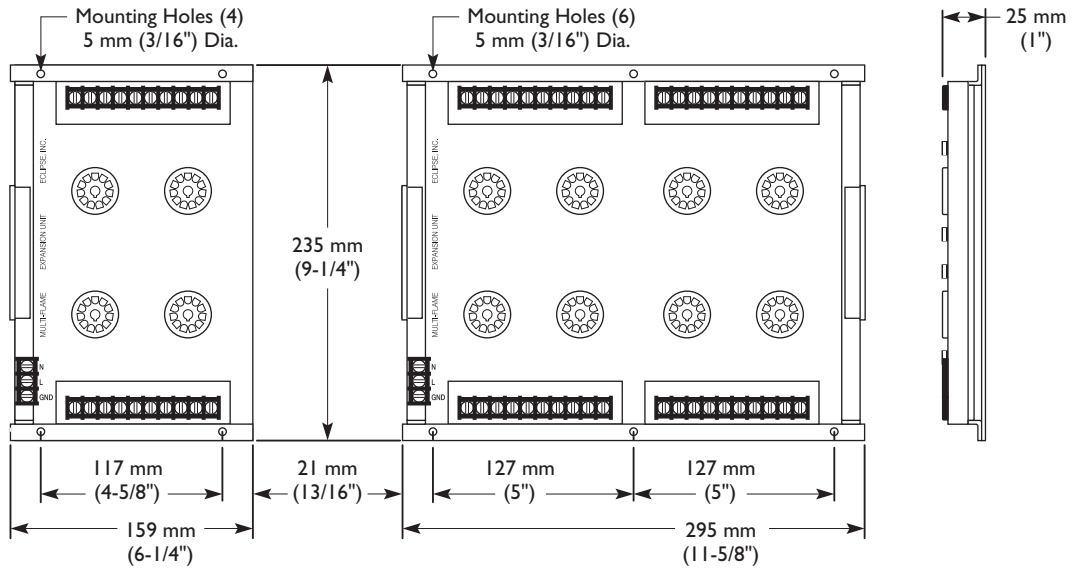

Remote Display (Shown with remote keypad and reset)

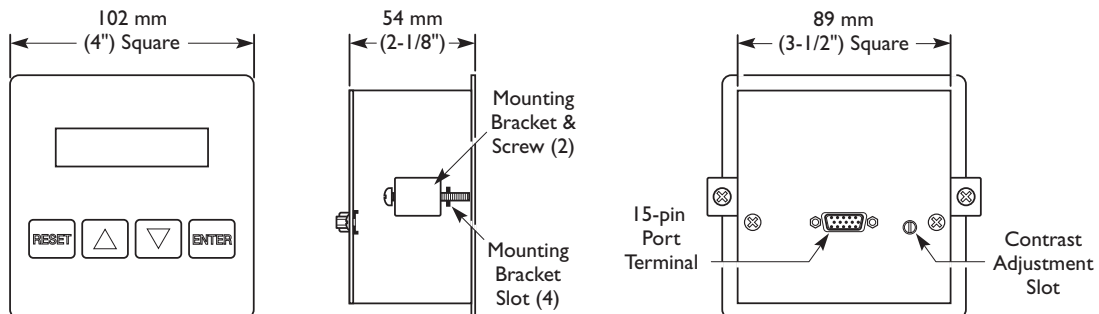

Modules Description 3

INTRODUCTION

MODULE DESCRIPTION AND IDENTIFICATION

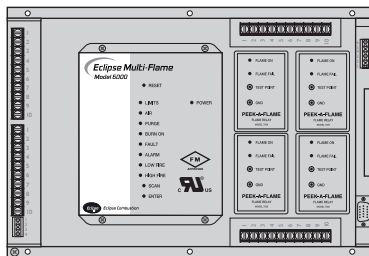

Relay Module Location

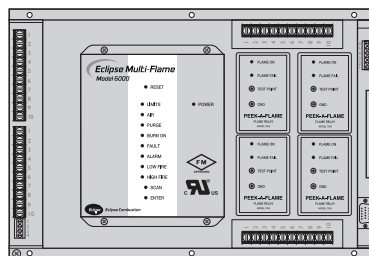

Logic Module Location

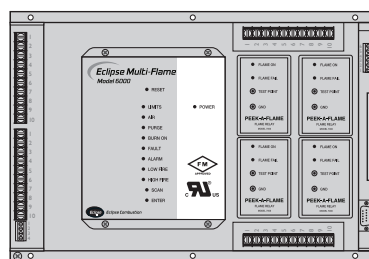

Power Module Location

In this section, you will find descriptions of the various modules which comprise the Multi-Flame multiple burner flame monitoring system, for both standard and optional items.

Relay Module

The relay module contains the output relays which provide power for operating the ignition coil, pilot valve, main valve, combustion fan, and alarm. This module is mounted in the first position on the left of the motherboard closest to the output terminals.

Logic Module

The logic module houses the microcomputer which provides all the sequential logic and safety start-up and shutdown circuitry. On the front of this module is the reset, scan and enter push-buttons, and status lights. This module is mounted in the second position from the left of the motherboard next to the relay module.

Power Module

The power module supplies the power required for the electronic circuitry. It is mounted in the motherboard to the right of the logic module. The green LED on the front indicates that power is on to the Multi-Flame.

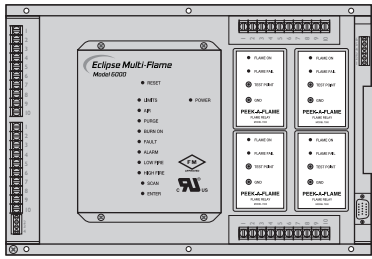

Peek-A-Flame Locations

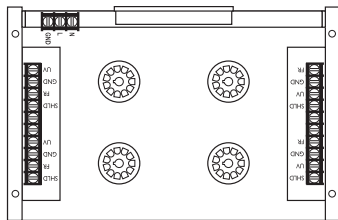
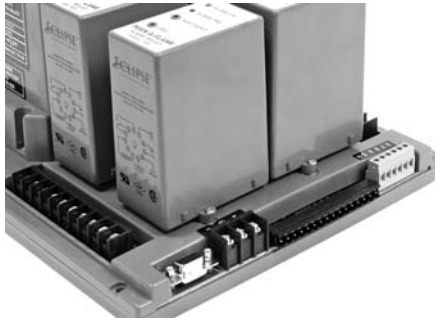

Expansion Board
(for four additional burners)

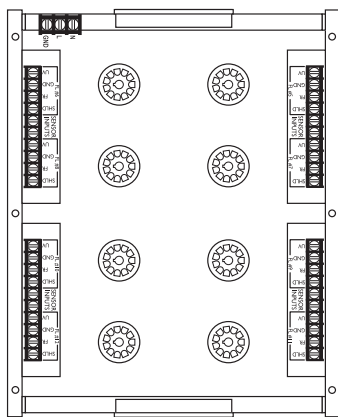

Expansion Board
(for eight additional burners)

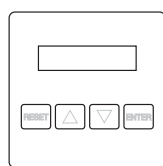

Remote Display

Peek-A-Flame Module

The Eclipse Peek-A-Flame is the flame sensing module of the Multi-Flame. One Peek-A-Flame is required for each burner in the system.

The Peek-A-Flames are installed into the motherboard by carefully inserting them into the round 11-pin sockets. Each Peek-A-Flame is held in place by two 4-40x1/2" screws through a tab into a threaded insert, as shown at left. On the front of the Peek-A-Flame module is a "Flame On" LED, which illuminates when a flame is detected at the corresponding burner. Directly below the "Flame ON" LED is a "Flame Fail" LED, which comes on for the first burner that loses the flame signal. On startup, the logic module sends a fast pulse to each Peek-A-Flame location, causing the LEDs to flash.

The Peek-A-Flame incorporates test point and ground (GND) connection jacks in the front of the unit. Using these, the flame signal strength of each burner can be measured using a 0-15VDC meter as explained and shown in "Flame Signal Strength" on page 32.

Expansion Board

The expansion board contains the mounting sockets and connection terminals for adding the additional Peek-A-Flame units needed for systems having more than four burners. There are two expansion boards available: one for adding up to four more burners and one for adding up to eight more burners. For systems monitoring 13 to 20 burners, two of the expansion boards for up to eight more burners are used.

A cable connects either expansion board to the motherboard, as well as two expansion boards together.

Note:



The four burner expansion board CANNOT be used in conjunction with the eight burner expansion board. DIP switch S6-7 must be set for the type of board used.

Remote Display

The remote display provides alphanumeric messages which indicate burner status as well as annunciate lockout condition in the Multi-Flame system. It also provides remote reset, a keypad and history logging capability.

A cable connects the remote display to the motherboard; this cable is available in 6 and 10 feet lengths.

DIP Switch Selection 4

INTRODUCTION

This section details the location, selection and description of the Multi-Flame DIP switches, which allow for sequence and timing functions as well as system configuration.



Caution:

To avoid electric shock, shut off the power supply when installing any control device. Flame monitoring systems must be installed by a qualified, licensed technician.

DIP SWITCH LOCATION

All of the DIP switches are located in the logic module, which is mounted in the second position from the left of the motherboard next to the relay module (see page 10 for logic module location).

DIP SWITCH ACCESS

To gain access to the DIP switches, remove the circuit board cover. To do this, remove the four screws which hold the cover to the motherboard. Remove the cover by pulling it evenly off of the circuit boards. The logic module is the middle board. Gently pull the logic module with a rocking motion to disengage the terminal pins at the module base. The photo below shows the DIP switch locations.

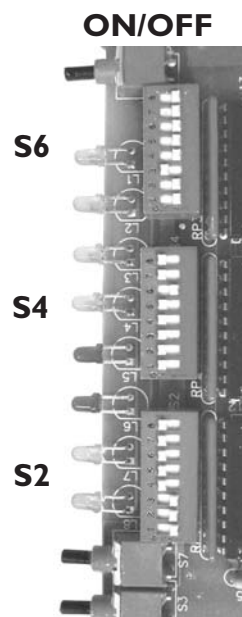

DIP SWITCH SETTINGS

ON/OFF

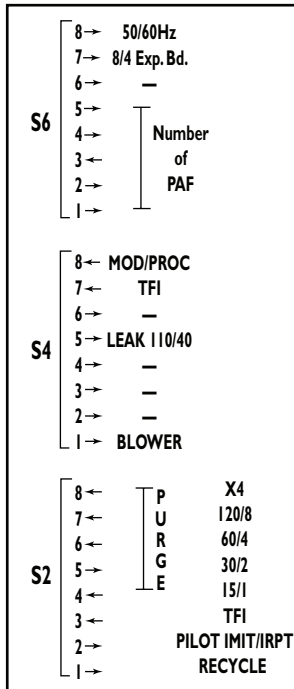

DIP Switch Functions

	ON	OFF
8	—	X4
7	Time	120 sec.
6	Not	60 sec.
5	Added	30 sec.
4		15 sec.

S2 Modulation Purge Time, S4 - 8 = ON

	ON	OFF
8	—	X4
7	Time	8 min.
6	Not	4 min.
5	Added	2 min.
4		1 min.

S2 Process Purge Time, S4 - 8 = OFF

IF time for ignition (TFI) needed is:	THEN SW3 of S2 DIP switch must be turned:	AND SW7 of S4 DIP Switch must be turned:
5 seconds	Off	Off
10 seconds	Off	On
15 seconds	On	Off or On

Trial-for-Ignition (TFI) Settings

S2 DIP Switches

The S2 DIP switches permit programming of timing and sequence functions of the Multi-Flame.



Note:

The S2 DIP switch settings at left show factory default settings; the actual settings of any of these switches will be determined by your system conditions.

SW1: Recycling mode selection (On=Recycling; Off=Non-recycling)

SW2: Pilot selection (On = Intermittent, where pilot remains on during burner cycle; Off = Interrupted, where pilot valve closes after main burner is established).

SW3: Trial-for-ignition (TFI) range selection; used with SW7 of the S4 DIP switch. See the table at left for proper selection.

SW4 through 8: Purge time selection; switch in off position selects indicated purge time. Selected purge times are additive. See illustration at left for exact times and Purge Time Example in appendix.

S4 DIP Switches

SW1: Fan operation on flame failure (on = fan turns off; off = fan stays on).

SW5: Leak test time (on=10 seconds; off=40 seconds).

SW7: Trial-for-ignition (TFI) range selection; used with SW3 of the S2 DIP switches. See the table at left for proper selection.

SW8: Purge mode; (on = modulation, off = process).

S6 DIP Switches

The S6 DIP switches permit selection of the number of burners in the system as follows:

No. of Burners	SW1	SW2	SW3	SW4	SW5
1	On	Off	Off	Off	Off
2	Off	On	Off	Off	Off
3	On	On	Off	Off	Off
4	Off	Off	On	Off	Off
5	On	Off	On	Off	Off
6	Off	On	On	Off	Off
7	On	On	On	Off	Off
8	Off	Off	Off	On	Off
9	On	Off	Off	On	Off
10	Off	On	Off	On	Off
11	On	On	Off	On	Off
12	Off	Off	On	On	Off
13	On	Off	On	On	Off
14	Off	On	On	On	Off
15	On	On	On	On	Off
16	Off	Off	Off	Off	On
17	On	Off	Off	Off	On
18	Off	On	Off	Off	On
19	On	On	Off	Off	On
20	Off	Off	On	Off	On

SW6: Not used.

SW7: Expansion Board Selection; (on = 8 unit expansion board, off = 4 unit expansion board)

SW8: Frequency Selection; (On = 50Hz, Off = 60 Hz)

Function Summary

5

INTRODUCTION

This section describes the function features of the Multi-Flame that can be found on the various terminal strips and the modules of the Multi-Flame. A Timing Sequence chart is located in the appendix.

COMBUSTION AIR FLOW CHECK TERMINAL

The Multi-Flame checks that the combustion air flow switch is open before startup, closed during operation and open again at burner shutdown, thus preventing operation with an air switch that is defective, maladjusted or jumpered.

MAIN FUEL VALVE PROOF-OF-CLOSURE TERMINAL

The Multi-Flame checks that the main fuel valve is closed before start-up and after burner shutdown. This arrangement requires a closed position switch on the main fuel valve.

LOW FIRE START TERMINAL

The system checks for the low fire start position prior to light-off. If voltage is not present on this terminal within 15 minutes, the Multi-Flame goes to lockout and alarm.

HIGH FIRE/HIGH FIRE PURGE CHECK TERMINAL

In the modulation purge mode, the system checks that the air modulation motor reached the high fire position during high fire purge. The modulation motor or air valve must be fitted with a high fire position switch, which is then connected to the high fire check terminal. An air flow or pressure switch that is set to prove sufficient purge air may be used instead of the high fire position switch. If voltage is not present on this terminal within 15 minutes, the Multi-Flame goes to lockout and alarm.

RECYCLE MODE

When selected, the Multi-Flame will restart the sequence after flame or air failure. The recycle mode allows the system to re-initiate the start-up sequence automatically, once the main burners have been operating for at least 20 seconds. If the pilot flame fails to light during recycling, the system will lock out and annunciate a pilot flame fail. If the recycle is successful and the main burners are operational for at least 20 seconds, the system is ready for another recycle. At no time will the system recycle in the event of pilot flame fail.

PILOT TEST MODE

This mode is entered by pressing the “Reset” and the “Enter” buttons simultaneously then releasing the “Reset” button but holding the “Enter” button for another 10 seconds. The limits light will flash off and on, indicating that the system is in the test mode.

In the pilot test mode, the Multi-Flame operates normally with the exception that the main valves are not energized, preventing the main burners from igniting.

To exit the pilot test mode, simply press the “Reset” button and the Multi-Flame will exit the pilot test mode and restart the sequence. Entering the pilot test mode erases the history log.

INTERRUPTED OR INTERMITTENT PILOT

Pilot mode is selected using the DIP switch (see “S2 DIP Switch Settings” on page 13). An interrupted pilot shuts off after the main flame is established. An intermittent pilot continues during the entire main flame firing cycle.

SPARK, PILOT FLAME AND MAIN FLAME SEPARATION

During the trial for ignition period (TFI), the pilot and ignition outputs remain energized. If all flames are on at the end of the TFI, the pilot output remains on and the ignition output is de-energized. After a five second delay to prove the pilot flame, the main output is energized.



Note:

All burners must light within the specified TFI or a pilot flame failure will occur. If one burner experiences either a pilot or main flame failure, then all burners will shut down. The failed burner will be indicated by the red “Flame Fail” light on the corresponding Peek-A-Flame.

AUXILIARY INPUTS

This feature provides four auxiliary inputs which are monitored by the Multi-Flame as alarm interlocks. This means that when the input voltage is interrupted, the system locks out and will announce on the optional remote display unit.

A voltage of 120 VAC must be present at the input for the Multi-Flame system to operate. If an auxiliary input loses its voltage for more than one second while the interlocks and limits input is powered, a lockout condition will occur. If the Multi-Flame is equipped with a remote display unit, the following message will occur:

<u>Aux. Input #1</u>	<u>Aux. Input #2</u>	<u>Aux. Input #3</u>	<u>Aux. Input #4</u>
AUX.LIM.#1 FAIL	AUX.LIM.#2 FAIL	AUX.LIM.#3 FAIL	AUX.LIM.#4 FAIL
LKOUT HHHH:MM:SS	LKOUT HHHH:MM:SS	LKOUT HHHH:MM:SS	LKOUT HHHH:MM:SS



Note:

Unused auxiliary inputs should be connected to 120 VAC.

HISTORY LOG

The history log is only accessible through the remote display unit or communication port, and when the Multi-Flame is in a “LOCKOUT” or “LIMITS OPEN” condition. The history log records the total number of operating cycles, total recycles, cause of last recycle and the last lockout messages up to a maximum of 10.

With a remote display available and the Multi-Flame in one of the two conditions described above, the history log can be accessed as follows:

1. Press and hold the ENTER key on the remote display unit until the following message appears:

TOTAL OPERATING CYCLES = XXXXXX (where X is a digit between 0 and 9).

The record number will display as long as the ENTER key is pressed. The scan button on the logic board also scrolls the history log.

2. If there has been a recycle, release and press the ENTER key to see: **RECYCLES TOTAL = XXXXXX** then release and press the ENTER key to see:

LAST RECYCLE BY AIR=XXXXXX or
LAST RECYCLE BY FLAME=XXXXXX

3. Release and press the ENTER key a second time. The record number of the lockout message will be displayed:

RECORD #X (where X is the number of the most recent lockout)4)

HISTORY LOG (CONTINUED)

4. Release the ENTER key and the most recent lockout message will display for seven seconds.
5. If you wish to see the next lockout message, press and release the ENTER key before the seven second time duration ends of the most recent lockout message display. This will prompt the next lockout message. If desired, continue this procedure until the maximum of ten lockout messages has been displayed (remember that the highest record number is the most recent lockout message).
6. Continued pressing and releasing of the ENTER key in less than seven seconds keeps the history log active and repeats the lockout message list; waiting longer than seven seconds deactivates the history log mode and the next display is the last sequence message before the history log was activated. For example, if the message "LIMITS OPEN" was displayed when the history log was activated, then that message will appear again after seven seconds.
7. If you wish to erase all of the lockout messages from the history log, press the RESET and ENTER keys simultaneously while the history log is active. Release the RESET key, but hold the ENTER key for another five seconds. Wait five seconds and press and release the RESET key.

MODULATION CONTACTS

The modulation feature incorporates "drive high," "drive low," and "automatic" contacts into the purge sequence. This feature allows the Multi-Flame to sequence internal dry contacts which can be used by the customer requiring a high fire purge of the combustion chamber before ignition.

The high fire purge time is selectable by means of S2 DIP switches on the logic board (see "S2 DIP Switch Settings" on page 13). With this option, the modulation terminals on J3 terminal strip will sequence as follows:

<u>Sequence Step</u>	<u>Internal Contact Connections</u>
High Fire Purge	Terminal 1 (COMMON) to Terminal 3 (HI FIRE)
Low Fire Start	Terminal 1 (COMMON) to Terminal 4 (LOW FIRE)
Automatic	Terminal 1 (COMMON) to Terminal 2 (AUTO)
Post Purge	Terminal 1 (COMMON) to Terminal 4 (LOW FIRE)
Power Off	Terminal 1 (COMMON) to Terminal 2 (AUTO)
Power On/Limits Off	Terminal 1 (COMMON) to Terminal 4 (LOW FIRE)
Alarm	Terminal 1 (COMMON) to Terminal 4 (LOW FIRE)

The Automatic step occurs 20 seconds after the main output has energized (see Table 10.1 beginning on page 38 and the Timing Sequence Chart in the appendix.) and allows the burner firing rate to be controlled by an automatic temperature con-

VALVE LEAK SENSING DEVICE INTERFACE

The Multi-Flame Valve Leak Sensing Device (VLSD or VDK) interface provides a 120 VAC output which triggers the start of the test period. An input is also provided which receives a 120 VAC signal from the VLSD. If the signal is received within the selected test period (40 or 110 seconds, see page 13), then the test has been successfully completed. This option includes the required sequential software to initiate the valve leak test on start-up and shutdown of the burners.

When the limits close to the Multi-Flame, the 120 VAC output to the VLSD is activated. If an optional remote display is connected, the following message will appear:

VALVE LEAKAGE UNDER TEST XX

(where X is the remaining seconds of the test).

If the VLSD does not activate the VLSD 120 VAC input within the test period, an alarm lockout will occur, and the following message will appear on the optional remote display:

VALVE LEAK FAIL LKOUT HHHH:MM:SS

If a valve leak occurs, the fan output on the Multi-Flame will be activated to purge the combustion chamber of gases.



Note:

If the VLSD input is not used, then it should be connected to 120 VAC.

REMOTE DISPLAY UNIT

The remote display with keypad allows remote reset and activation of the history log option. It is panel mountable and features a liquid crystal display in a 1/4 DIN housing. It connects to the Multi-Flame by a six or ten foot cable. The display incorporates the following features:

1. Provides status messages for the Multi-Flame sequence. (See Section 10)
2. Indicates lockout conditions when they occur, as well as the amount of time into the sequence when the lockout occurred and the amount of time elapsed from lockout.
3. Provides continuous monitoring of each burner's flame signal strength during main burner operation. (Pressing ENTER once will lock on a particular burner's status; pressing ENTER a second time will resume scrolling).
4. Incorporates a remote reset key.
5. Provides the interface required for the History Log.
6. Incorporates keys for pilot test mode.

COMMUNICATION INTERFACES

Terminals 1, 5, and 6 on Multi-Flame terminal strip J7 provide a serial ASCII output communication interface for remotely monitoring the system sequence and status using a terminal or a modem; refer to Section 10 for the types of messages sent by the Multi-Flame.

The communications protocol is 8 bit, no parity, 1 stop bit and 1200 baud. This feature is provided standard as a RS232 interface. The RS485 interface is optional.

Sending a carriage return (<CR> = ASCII Hex 0D) from the terminal causes the Multi-Flame to retransmit the last message. Sending a space character (<SP>=ASCII Hex 20) stops port transmission until the next cycle or until receipt of a <CR>. Sending a CTRL-E (<ENQ> = ASCII Hex 05) accesses the optional history log. Each transmission of <ENQ> acts like the pressing of the ENTER key on the remote display. See page 16. See appendix for example of the text string output.

LOGIC MODULE STATUS LIGHTS & PUSH BUTTONS

The logic module provides all the sequential logic, and safety start-up and shutdown circuitry. On the front of the module is the reset, scan and enter push buttons, and status lights. This section describes their respective functions.

LOGIC MODULE

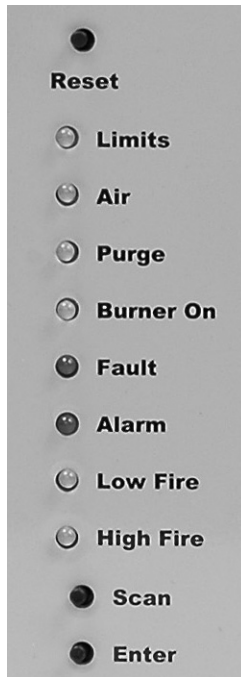

Reset

This push-button resets the control. It is also used with the ENTER button to enable the pilot test mode.

Limits

This green LED illuminates when the operation limits are made. These limits are wired in series to terminal J1-1. This input becomes energized to begin the burner sequence. When in the test mode, this LED flashes (see “Pilot Test Mode” on page 15).

Air

This green LED illuminates when the air switch is closed and power is thereby applied to the air switch input. The Multi-Flame also checks this input for an air switch short (see “Combustion Air Flow Check Terminal” on page 14).

Purge

This green LED illuminates whenever the combustion blower is energized, including the purge period and the main burner period of the sequence. It blinks on and off while the purge is in process and remains constant when the purge process is complete.

Burner On

This green LED illuminates when the main gas valve is energized, permitting gas flow to all the burners.

Fault

This red LED illuminates when a system fault is detected (see “System Faults” on page 21).

Alarm

This red LED illuminates when an alarm condition causes a system lockout (see “System Lockout Conditions” on page 21).

Low Fire

This green LED illuminates during the low fire period of the purge cycle.

High Fire

This green LED illuminates during the high fire period of the purge cycle.

Scan

This push-button can be used to scroll the history log.

Enter

This push-button is used with the RESET button to enable the pilot test mode.

SYSTEM FAULTS

SYSTEM LOCKOUT CONDITIONS

A system fault (illuminated by the fault LED on the logic cards) prevents gas ignition but does not immediately lock out the system. System fault conditions are as follows:

1. If a flame is detected out of sequence, which may be caused by:
 - a) a faulty scanner
 - b) electrical interference on the sensor leads
 - c) a flame exists in the burner due to a gas leak or other condition.
2. Air flow switch closed before start-up.

A system lockout will occur (illuminated by the alarm LED on the logic card) for any of the following conditions:

1. Air failure—loss of combustion anytime during the operational cycle.
2. Pilot flame fail—loss of flame during the trial for pilot ignition period.
3. Main flame fail—loss of flame during the main burner trial for ignition.
4. Main fuel valve—open after cycle shutdown or before start-up with interlocks closed.
5. Unmatched burners—the number of Peek-A-Flames installed does not match the number selected on the DIP switches (see “S6 DIP Switch Settings” on page 13).
6. Relay fail—failure of Multi-Flame internal relays.
7. Low fire fail—low fire switch open for more than 15 minutes prior to trial for ignition.
8. High fire fail—high fire switch has not closed within 15 minutes of high fire purge.
9. Flame fail—loss of flame after main flame has been established.
10. Auxiliary input fail—loss of input voltage to any of the four “Aux” terminals after the limit input is made.
11. Valve leak fail—valve leak sensing device has detected a leak.
12. Wiring error which puts external voltage on any of the output terminals.
13. Welded internal contacts or other malfunctions in the Multi-Flame.
14. A system fault condition that lasts longer than 30 seconds.

System Installation

6

INTRODUCTION

In this section, the necessary procedures are detailed to integrate a Multi-Flame into a burner system; Figure 6.1 (page 25) illustrates the various terminal strips mentioned.



Note:

Shut off the power supply before any module is removed or replaced from the unit, including the remote display.



Caution:

Installation and maintenance must conform with the National Electrical Code and all other national and local codes and authorities having jurisdiction.

INTERLOCKS AND LIMIT SWITCH INPUT

Interlocks are generally pressure or temperature switches which, when activated, start the burner. Limit switches are generally pressure, temperature and other switches which, when activated, stop the burner. The interlocks and limit switches are wired in series. A break in this circuit will shut the burner down, but will not produce an alarm. This input is considered the normal operation control input to the Multi-Flame system.

COMBUSTION AIR SWITCH INPUT

This input is for monitoring the combustion air switch separately from other interlocks and limits. When wired to this input, the air switch will be proven open before start-up and after shutdown. It will also be proven closed 10 seconds after the combustion air blower is energized.

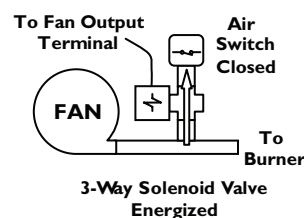
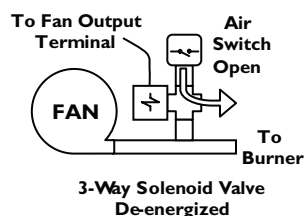

If the air switch opens during the main firing cycle, the system will either lockout or recycle, depending on the DIP switch selection.

If this terminal is not used, place a jumper between the combustion blower output (terminal 3 on terminal strip J2) and the air switch input (terminal 2 on terminal strip J1). This jumper must not be used in place of a required air flow switch interlock.

If the combustion air blower is controlled outside of the Multi-Flame system, then a three way solenoid valve must be connected between the air switch port and the blower sensing port. The valve de-energized state should vent the switch to ambient pressure. The energized state then connects

COMBUSTION AIR SWITCH INPUT (CONTINUED)

the air switch to the blower sensing port. Power the valve from the blower output terminal J2-3. If accepted by local codes, the air switch could be wired between the combustion blower output and the air switch input. Connecting the air switch in this manner will satisfy the open contact (air short) check on the switch.



Caution:

Do not connect multiple ignition coils in excess of output relay contact rating

IGNITION WIRING

Route ignition wiring a sufficient distance from all sensors and other low-voltage wiring to avoid electrical interference, which may cause erratic operation of the Multi-Flame system. Keep the high-voltage wire run from the ignition transformer as short as possible. The best condition is to mount the ignition transformer close to the burner and keep a low-impedance path from the burner ground to the case of the transformer. Make sure the high-voltage lead and ground return paths do not create a loop antenna around the Multi-Flame and sensor wiring.

COMMUNICATION WIRING

Route communication wiring, using shielded cable, a sufficient distance from ignition and other high voltage wiring to avoid electrical interference.

POWER SUPPLY

All input power must be single phase 120 VAC, 60/50 Hz selectable, see page 13. All circuits must have a common 15 amp fuse and disconnect. The neutral must be grounded. **Do not use solid-state triac output devices in any of the input circuits.** 120 VAC wiring must be at least 90°C 16 AWG minimum and satisfy all applicable codes.

LOW FIRE POSITION INPUT

It is possible to wire the system for checking low fire start position prior to pilot ignition. To use this feature, the low fire start switch must be connected to the low fire start input (terminal 4 on terminal strip J1). If this feature is not used, a jumper must be placed between terminals 1 and 4 on terminal strip J1.

MAIN VALVE PROOF-OF-CLOSURE

The system can be wired to check for the proof of valve closure (POVC) switch on the main gas valve prior to start-up and after the end of the burner cycle.

To use this feature the POVC switch must be connected to the POVC switch input (terminal 3 on terminal strip J1). If this feature is not used, a jumper must be placed between terminals 2 on terminal strip J2 and 3 on terminal strip J1.

HIGH FIRE POSITION INPUT

The system can be wired to check for high fire position during the high fire purge portion of the sequence. To use this feature, the high fire position switch must be connected to the high fire input (terminal 5 on terminal strip J1). If this feature is not used, a jumper must be placed between terminals 1 and 5 on terminal strip J1.

AUXILIARY INPUTS

The system can be wired to check auxiliary status conditions with the four auxiliary inputs. To use this feature, the auxiliary input switches must be wired to the auxiliary inputs (terminals 7,8,9 and 10 on terminal strip J1). If this feature is not used, these inputs must be connected to 120 VAC.

REMOTE RESET

This feature permits remote mounting of a switch to reset the Multi-Flame. To use this feature, a normally closed remote reset switch must be wired between terminals 1 and 4 on terminal strip J7. When it is depressed or actuated, the connection between the terminals is momentarily interrupted and resets the Multi-Flame. This is a low voltage signal circuit that must be routed separately from other control voltage wiring. Use two-conductor shielded cable with the shield connected on one end only to terminal 1 of J7.



Note:

If reset is required from both the display and the J7 terminals, use a normally open switch.

EXPANSION BOARDS

There are two different expansion boards available: one for up to four additional burners and one for up to eight additional burners. Either expansion board is mounted on the sub-panel separate from the Multi-Flame motherboard.



Note:

The four burner expansion board CANNOT be used in conjunction with the eight burner expansion board. DIP switch S6-7 must be set for the type of board used.

Power to the expansion board is supplied to its J1 terminals from the main chassis J9 terminals. Match the terminal designations L and N and GND and do not connect to other equipment.

The connection to the motherboard is made via a cable which joins two plug connectors at J8 on the motherboard and J2 on the expansion board. The connections between the two plugs are to matching numbers (i.e., pin 1 on J8 connected to pin 1 on J2).

The same two-plug connector cable is used in systems for 13 to 20 burners where two of the 8 burner expansion boards are linked to the motherboard.

EXPANSION BOARDS (CONTINUED)

The first expansion board is connected to the motherboard as described above, while J2 of the second expansion board is connected to J7 of the first expansion board.

Sensor connections are made for the corresponding Peek-A-Flame at terminals J3 and J4 on the 4-burner expansion board or J3, J4, J5, and J6 on the 8-burner board.

REMOTE DISPLAY

When installed, the remote display must be grounded. Panel mounting is through a 1/4 DIN cutout (see page 9). Use either the six or ten foot cable to connect it to the motherboard.



Warning:
Power must be off when inserting or removing the cable.

Figure 6.1 Terminal Strips Identification & Location
Main Chassis (For two to four burners)

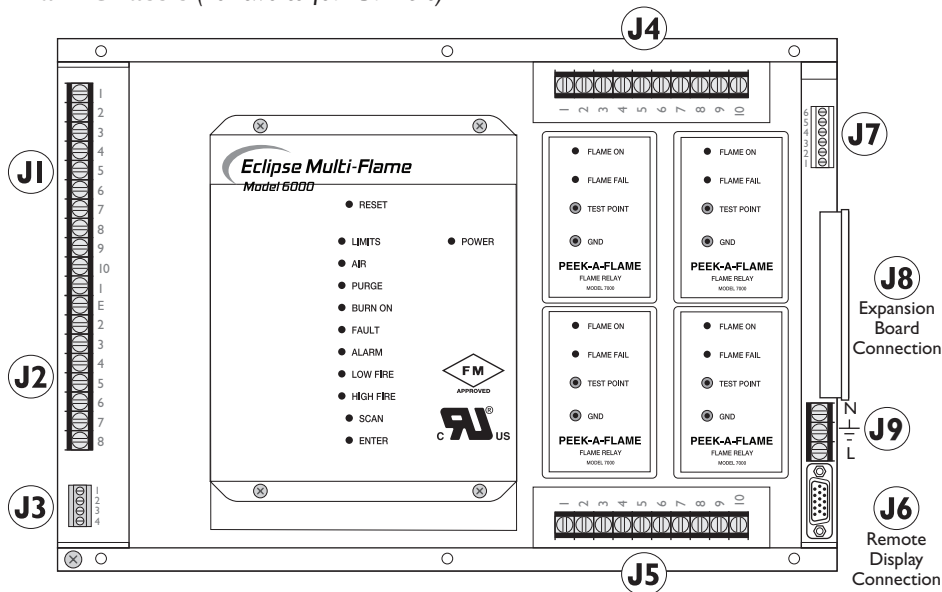

Expansion Boards

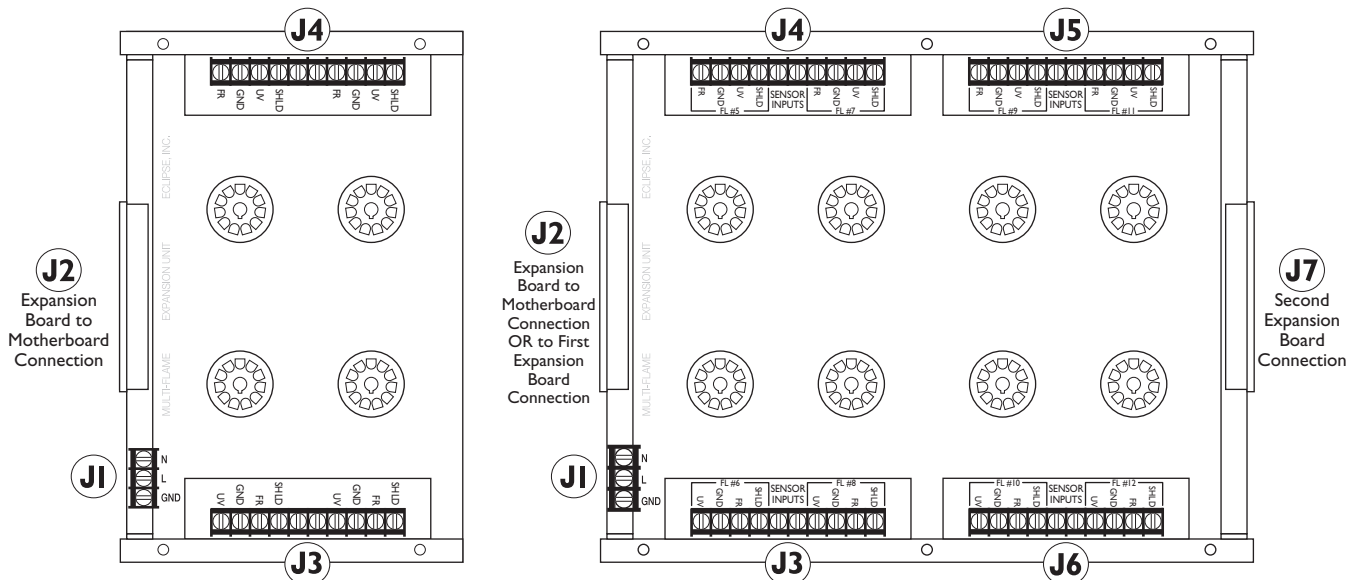
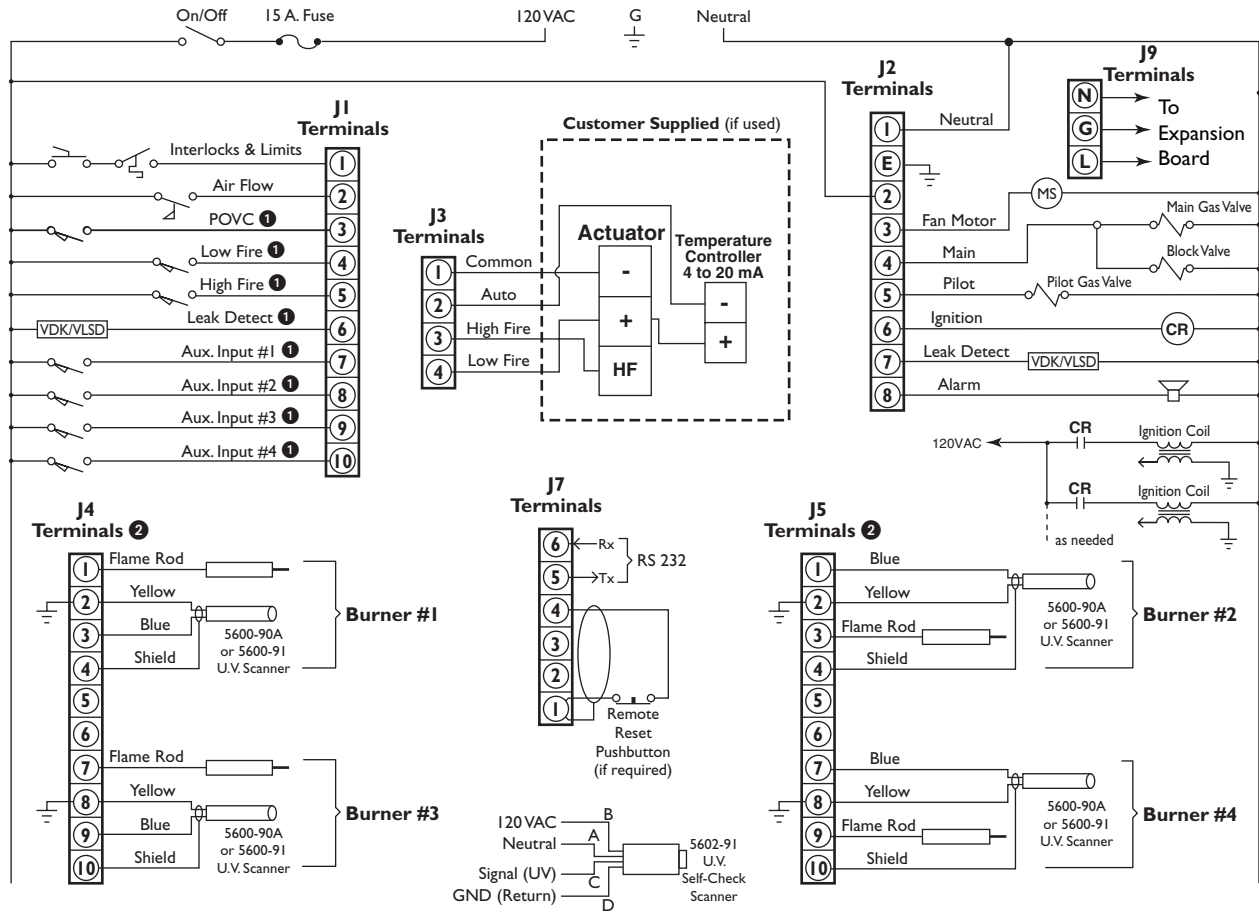

Figure 6.2 Wiring Diagram & Connections—Main Chassis



- ① When not used, must be tied into 120VAC.
- ② Using both sensors isn't mandatory; you may use a flame rod, or a UV scanner, or both.

J1 (Input) Terminals

- 1 – Limits Input
- 2 – Air Switch Input
- 3 – POVC Switch Input ①
- 4 – Low Fire Switch Input ①
- 5 – High Fire Switch Input ①
- 6 – VDK/VLDS Input ①
- 7 – Aux. #1 ①
- 8 – Aux. #2 ①
- 9 – Aux. #3 ①
- 10 – Aux. #4 ①

Auxiliary Inputs

J3 (Modulation) Terminals

- 1 – Common
 - 2 – Auto
 - 3 – Hi Fire
 - 4 – Low Fire
- Modulation Motor Connections for High Fire & Low Fire Start**

J4 (Sensors/Burners 1 & 3) Terminals ②

- 1 – Flame Rod
 - 2 – Ground (Yellow)
 - 3 – U.V. (Blue)
 - 4 – Shield Connection
 - 5 – Not Used
 - 6 – Not Used
 - 7 – Flame Rod
 - 8 – Ground (Yellow)
 - 9 – U.V. (Blue)
 - 10 – Shield Connection
- Burner #1**
- Burner #3**

J5 (Sensors/Burners 2 & 4) Terminals ②

- 1 – U.V. (Blue)
 - 2 – Ground (Yellow)
 - 3 – Flame Rod
 - 4 – Shield Connection
 - 5 – Not Used
 - 6 – Not Used
 - 7 – U.V. (Blue)
 - 8 – Ground (Yellow)
 - 9 – Flame Rod
 - 10 – Shield Connection
- Burner #2**
- Burner #4**

J2 (Output) Terminals

- 1 – Neutral
 - E – Earth Ground
 - 2 – 120VAC
 - 3 – Fan
 - 4 – Main Gas Valve
 - 5 – Pilot Gas Valve
 - 6 – Ignition Transformer
 - 7 – VDK/VLDS
 - 8 – Alarm
- Multi-Flame Power Inputs**
- Outputs**

J7 (Interface) Terminals

- 6 – RS 232/RS 485 Interface
- 5 – RS 232/RS 485 Interface
- 4 – Reset
- 3 – Scan
- 2 – Enter
- 1 – Ground

J9 Expansion Power

- 3 – N
- 2 – G
- 1 – L

Figure 6.3 Wiring Diagram & Connections—Expansion Board for up to Four Burners

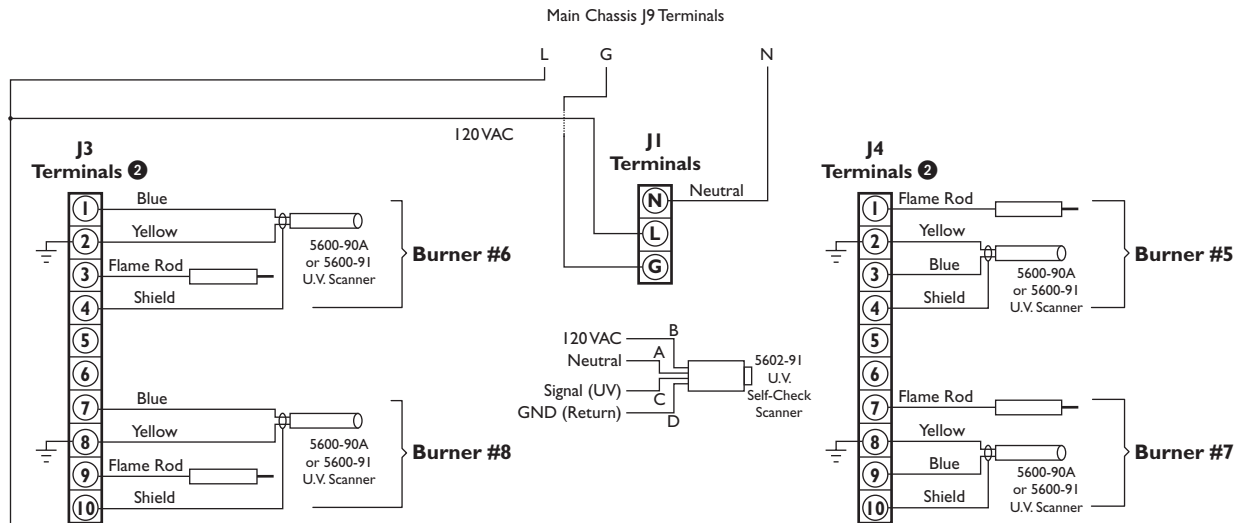

② Using both sensors isn't mandatory; you may use a flame rod, or a UV scanner, or both.

J1 (Input) Terminals

- 1 – Neutral
 - 2 – 120VAC
 - 3 – Ground
- Expansion Power Inputs**

J3 (Sensors/Burners 6 & 8) Terminals ②

- 1 – U.V. (Blue)
 - 2 – Ground (Yellow)
 - 3 – Flame Rod
 - 4 – Shield Connection
 - 5 – Not Used
 - 6 – Not Used
 - 7 – U.V. (Blue)
 - 8 – Ground (Yellow)
 - 9 – Flame Rod
 - 10 – Shield Connection
- Burner #6**
Burner #8

J4 (Sensors/Burners 5 & 7) Terminals ②

- 1 – Flame Rod
 - 2 – Ground (Yellow)
 - 3 – U.V. (Blue)
 - 4 – Shield Connection
 - 5 – Not Used
 - 6 – Not Used
 - 7 – Flame Rod
 - 8 – Ground (Yellow)
 - 9 – U.V. (Blue)
 - 10 – Shield Connection
- Burner #5**
Burner #7



Note: Connect J1 of Expansion Board to J9 of main chassis.

Figure 6.4 Wiring Diagram & Connections—Expansion Board for up to Eight Burners

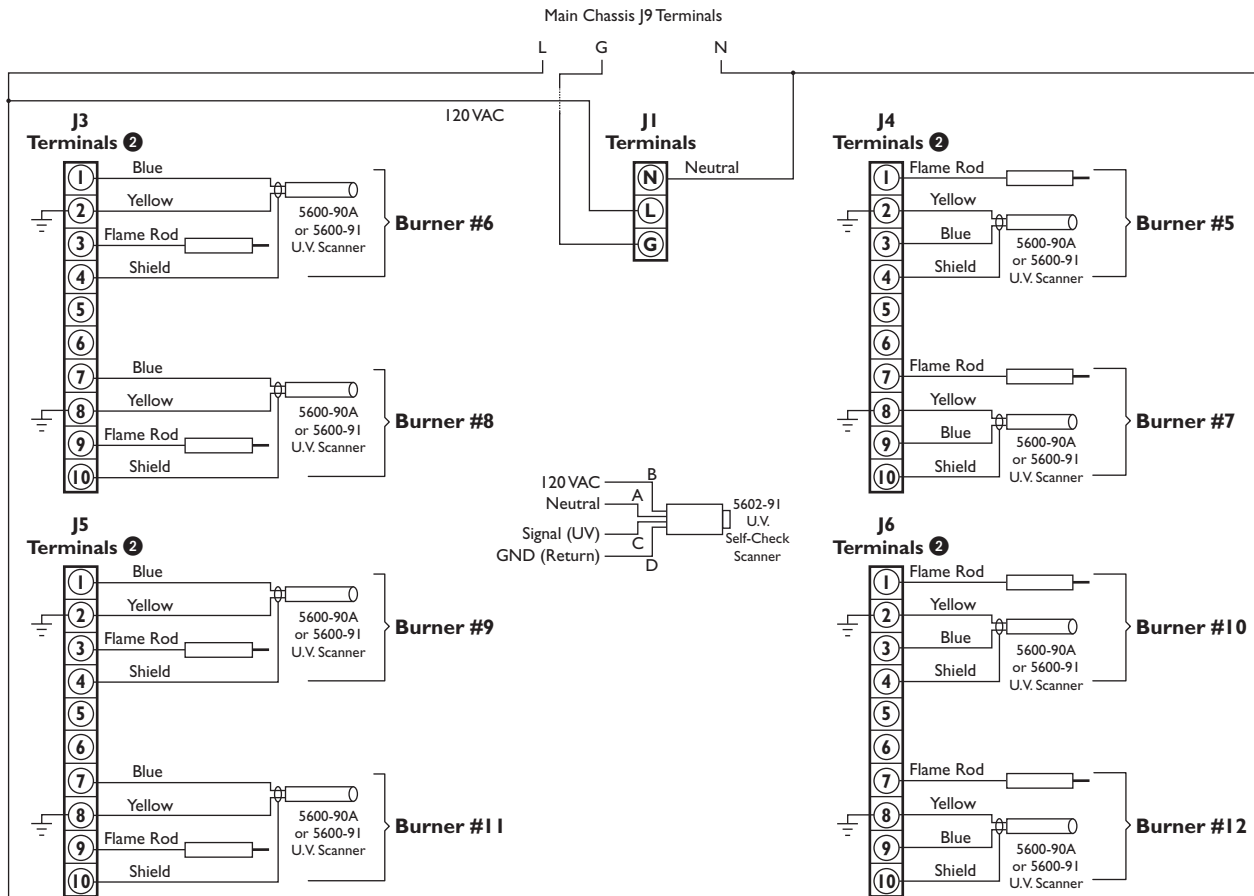

② Using both sensors isn't mandatory; you may use a flame rod, or a UV scanner, or both.

J1 (Input) Terminals

- 1 – Neutral
 - 2 – 120 VAC
 - 3 – Ground
- Expansion Power Inputs**



Note: Connect J1 of expansion board to J9 of main chassis.

J3 (Sensors/Burners 6 & 8) Terminals ②

- 1 – U.V. (Blue)
 - 2 – Ground (Yellow)
 - 3 – Flame Rod
 - 4 – Shield Connection
 - 5 – Not Used
 - 6 – Not Used
 - 7 – U.V. (Blue)
 - 8 – Ground (Yellow)
 - 9 – Flame Rod
 - 10 – Shield Connection
- Burner #6**
- Burner #8**

J4 (Sensors/Burners 5 & 7) Terminals ②

- 1 – Flame Rod
 - 2 – Ground (Yellow)
 - 3 – U.V. (Blue)
 - 4 – Shield Connection
 - 5 – Not Used
 - 6 – Not Used
 - 7 – Flame Rod
 - 8 – Ground (Yellow)
 - 9 – U.V. (Blue)
 - 10 – Shield Connection
- Burner #5**
- Burner #7**

J5 (Sensors/Burners 9 & 11) Terminals ②

- 1 – U.V. (Blue)
 - 2 – Ground (Yellow)
 - 3 – Flame Rod
 - 4 – Shield Connection
 - 5 – Not Used
 - 6 – Not Used
 - 7 – U.V. (Blue)
 - 8 – Ground (Yellow)
 - 9 – Flame Rod
 - 10 – Shield Connection
- Burner #9**
- Burner #11**

J6 (Sensors/Burners 10 & 12) Terminals ②

- 1 – Flame Rod
 - 2 – Ground (Yellow)
 - 3 – U.V. (Blue)
 - 4 – Shield Connection
 - 5 – Not Used
 - 6 – Not Used
 - 7 – Flame Rod
 - 8 – Ground (Yellow)
 - 9 – U.V. (Blue)
 - 10 – Shield Connection
- Burner #10**
- Burner #12**

Sensor Installation

7

INTRODUCTION

This section describes the proper wiring, installation and sighting considerations for all sensors that can be used with a Multi-Flame.



Warning

Incorrect sensor installation may cause the sensor to generate a false flame signal, possibly resulting in the collection of unburned fuel in the combustion chamber. This unburned fuel creates the potential for explosions which can result in injuries, property damage, or death. Be certain that the flame sensor detects acceptable pilot and main flames only.

SENSOR WIRING

Route sensor wiring a sufficient distance from ignition and other high voltage or high current wiring to avoid electrical interference. Interference from ground currents, nearby conductors, radio-frequency emitters (wireless devices), and inverter drives can induce false flame signals. Shielded cables can help reduce interference with the shield connected to ground at the control end only. The wire type and its capacitance (picofarads or microfarads) to ground may cause low signal problems, so a grounded shield may decrease the signal due to the cable's internal capacitance. Multiple U.V. tube-type sensor leads run together without shielding may interfere or "cross talk", so the shield or flexible armor must be grounded to prevent this situation. For flame rod sensor runs approximately 100 feet (30 meters) or greater, use Eclipse part number 21741 coax cable. To achieve the maximum wiring distance, the shield should not be grounded (keep in mind that an ungrounded shield provides less protection against electrical interference).



Note:

Unshielded sensor wiring must not be run in common with other wires; it must be run in separate conduit. Multiple unshielded flame sensor wiring must not be run together for long lengths in a common conduit or wireway. Use #14 to #18 AWG wire suitable for 90°C (194°F) and 600 volt insulation, or better grade if required by the application. Multiple shielded cables can be run in a common conduit.

FLAME RODS

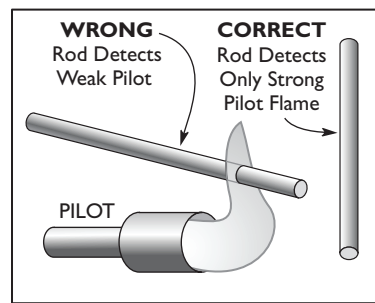
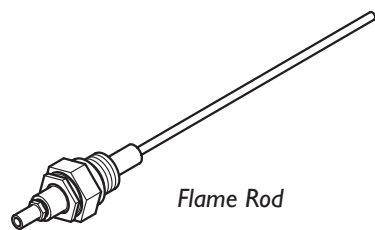

Flame Rod Position

Flame rods should be used only on gas burners. They accumulate soot on oil burners, causing nuisance shutdowns and unsafe operating conditions.

See the burner manufacturer's literature for flame rod mounting location. When installing flame rods, please consider the following:

1. Keep the flame rod as short as possible and at least 13 mm (1/2") away from any refractory.
2. Position the rod into the side of both the pilot and main flames, preferably at a descending angle to minimize drooping of the flame rod against burner parts. Flame rod position must adequately detect the pilot flame at all burner draft conditions. Extend the rod 13 mm (1/2") into nonluminous flames, such as blue flames from burning an air/gas mixture. For partially luminous flames, such as atmospheric air/gas mixtures, place the rod at the edge of the flame.
3. Provide a burner/flame grounding area that is at least four times greater than the flame rod area contacting the flame. The flame rod/burner ground ratio and position of the rod in the flame may need adjustment to yield maximum flame signal strength.
4. Ignition interference from the spark plug may increase or decrease the flame signal strength. Reversing the ignition transformer primary leads may reverse this effect. Reducing the spark gap or adding grounding area between the flame rod and spark plug may eliminate the interference.

SCANNERS

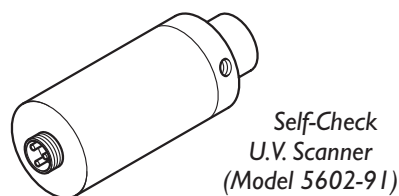
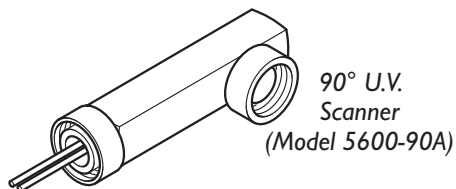
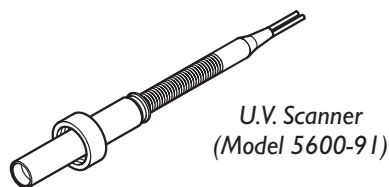

Use only Eclipse model 5600-90A, 5600-91, 5602-91 or 5600-91N4 scanners. Consult the burner manufacturer's instructions for mounting location. When installing scanners, please consider the following:

1. Position the scanner within 457 mm (18") of the flame. Consult Eclipse for longer distances.
2. Bushing threads are 1/2 inch F.N.P.T. for scanner models 5600-90A, 5600-91 and 5600-91N4; model 5602-91 has 1 inch F.N.P.T. bushing threads.
3. The ambient temperature limits of each scanner varies, (see specifications). For higher temperatures, use Eclipse heat insulator 49099 or the Heat Block Seal, Model 23HBS, that has a purge fitting.
4. An optional magnifying lens (Eclipse #49600-98) may also be used to increase the flame signal strength in difficult sighting situations.

SCANNER SIGHTING CONDITIONS

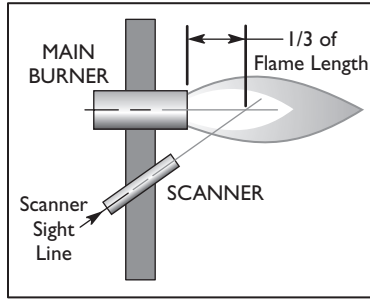

U.V. Scanner Sighting

Aim scanners at the third of the flame closest to the burner nozzle, as shown at left. This is especially true for oil flames which typically have less UV radiation in the outer flame. The scanner should view the intersection of the pilot and main flames. When sighting scanners, please consider the following:

1. Sight the scanner away from the ignition spark. Sighting the spark or its reflections from burner internals can be misinterpreted as a flame signal.
2. Do not allow the scanner to detect a pilot flame that is too small to ignite the main burner.
3. Perform a minimum pilot test when installing or adjusting any pilot or main burner system; see "Minimum Pilot Test" on page 32.

Test Procedures

8

INTRODUCTION

FLAME SIGNAL STRENGTH

MINIMUM PILOT TEST



Voltmeter hook-up to a Peek-A-Flame

This section describes the test procedures that must be performed after installation to insure that the Multi-Flame is operating properly; these procedures are mandatory.

Insert the positive probe of a 0-15 VDC, (> 200Kohm impedance) meter into the test point on the Peek-A-Flame, as shown in the photo at left. Connect the negative probe to ground. A good flame signal strength will read between 6 and 11 VDC; anything below 4 VDC is inadequate.

Run the following test procedures to ensure that the sensor will not detect a pilot flame too small to reliably light the main flame:

1. Manually shut off the fuel supply to the burner, but not to the pilot.
2. Start the system normally.
3. To enter the pilot test mode, press the RESET and ENTER buttons simultaneously. Then release the RESET button but keep the ENTER button depressed for another 10 seconds. The Limits LED will blink, signalling that the system is in the pilot test mode.
4. The control will hold the operating sequence at the pilot flame step. Measure signal strength as described above.
5. Reduce pilot fuel until the flame relay drops out. Increase pilot fuel until the flame signal is greater than 4 VDC, and flame relay just manages to pull in. This is the minimum pilot. If you don't think this flame will be able to safely light the main burner, realign the sensor so that it requires a larger pilot flame and repeat steps 2 through 5.
6. Push the RESET button to exit the test mode and begin the normal start-up sequence again.
7. When the sequence reaches the main flame trial for ignition, smoothly restore the fuel supply to the burner. If the main burner does not light within five seconds, immediately shut off the burner supply to shut down the system. Realign the sensor so that it requires a larger pilot flame. Repeat steps 1 through 6 until the main burner lights off smoothly and reliably.

PILOT FLAME FAILURE TEST

1. Manually shut off the fuel supply to one individual pilot and main burner, or all burners if the system has a single fuel supply.
2. Place system in pilot test mode (please refer to page 15).
3. Start the system normally. The controller should lock out. If it doesn't, then the controller is detecting a false flame signal (see Section 7). Find the problem and correct it before resuming normal operation. The burner at which a flame fails will be identified by a red "Flame Failure" LED on the corresponding Peek-A-Flame.
4. Repeat steps 1 through 4 until all burners have been tested.

MAIN FLAME FAILURE TEST (FOR INTERRUPTED PILOT SYSTEMS)

1. Manually shut off the fuel supply to the main burner, or all burners if the system has a single fuel supply, but not to the pilot.
2. Start the system normally. This should ignite the pilot and lock out after pilot interruption. The burner at which a flame fails will be identified by a red "Flame Failure" LED on the corresponding Peek-A-Flame. If the system does not lock out, the controller is detecting a false flame signal (see Section 7). Find the problem and correct it before resuming normal operation.
3. Repeat steps 1 through 3 until all burners have been tested.

SPARK SIGHTING TEST

1. Manually shut off the fuel supply to the pilot and main burner.
2. Start the system normally.
3. Measure the flame signal as described in "Flame Signal Strength" in this section.
4. If a flame signal greater than 4VDC is measured for more than three seconds during the trial for ignition, the sensor is picking up a signal from the spark plug or the ignition current is interfering with the sensor wiring. If this is an abnormal condition, correct before resuming normal operation.

LIMITS AND INTERLOCK TESTS

Periodically check all interlock and limit switches by manually tripping them during burner operation to make sure they cause the system to shut down.



Warning

Never operate a system that is improperly adjusted or has faulty interlocks or limit switches. Always replace faulty equipment with new equipment before resuming operation. Operating a system with defective safety equipment can cause explosions, injuries, and property damage.

Maintenance & Troubleshooting 9

INTRODUCTION

MAINTENANCE

MONTHLY CHECKLIST

This section is divided into two parts:

- Describing the maintenance procedures.
- Helping to identify problems that may occur, and giving advice on how to solve these problems.

Preventative maintenance is the key to a reliable, safe and efficient system. The core of any preventive maintenance program is a list of periodic tasks.

In the paragraphs that follow are suggestions for a monthly list and a yearly list.



Note:

The monthly list and the yearly list are an average interval. If your environment is dirty, then the intervals may be shorter.



Caution:

Turn off power before disconnecting or installing sensors, controls or modules.

- Inspect flame-sensing devices for good condition and cleanliness. Keep the lens of scanners clean with a soft, damp cloth, since small amounts of dust will measurably reduce the flame signal strength. Wash the flame rod electrode and insulator with soap and water, then rinse and dry thoroughly.
- Test all the alarm systems for proper signals.
- Check ignition spark electrodes and check proper gap.
- Test interlock sequence of all safety equipment as described in Test Procedures: manually make each interlock fail, noting what related equipment closes or stops as specified by the manufacturer.
- Test flame safeguard by manually shutting off gas to the burner.

YEARLY CHECKLIST

- Test (leak test) safety shut-off valves for tightness of closure.
- Test pressure switch settings by checking switch movements against pressure setting and comparing with actual impulse pressure.
- Visually check ignition cable and connectors.
- Make sure that the following components are not damaged or distorted:
 1. the burner nozzle
 2. the spark plugs
 3. the flame sensors
 4. the flame tube or combustion block of the burner

TROUBLESHOOTING

PROBLEM	POSSIBLE CAUSE	SOLUTION
Cannot initiate start sequence	• Main valve is not closed.	Check proof-of-valve-closure switch.
	• Air pressure switch has not made contact.	Check air pressure switch adjustment Check air filter. Check blower rotation. Check outlet pressure from blower.
	• High gas pressure switch has tripped.	Check incoming gas pressure; adjust gas pressure if necessary. Check pressure switch setting and operation.
	• Low gas pressure switch has tripped.	Check incoming gas pressure; adjust gas pressure if necessary. Check pressure switch setting and operation.
	• Malfunction of flame safeguard system such as a shorted-out flame sensor or electrical noise in the sensor line.	Have qualified electrician investigate and rectify.
	• Purge cycle not completed.	Check flame safeguard system, or purge timer.
	• Main power is off.	Make sure power is on to control system.
	• No power to control unit.	Call qualified electrician to investigate.
Scrambled messages on remote display.	• Improper grounding in system.	Check grounding in system.
“UNSAFE AIR SHORT” message appears on display.	• Improperly adjusted air switch • Air switch either shorted or wired wrong.	Check air switch settings. Check wiring to air switch.
Burner flame fails but no flame failure indication occurs.	• A faulty scanner.	Check scanner as explained in checklists in “Maintenance” portion of this Section.
	• Improperly connected sensor wires.	Check wiring diagram on page 26 as well as appropriate sensor information in Section 7.
	• Electrical interference from other current carrying wires.	Check Note information on page 29 regarding sensor wiring.
CLOCK FAIL message appears on display	• Improper setting of S6-8 • Harmonics or EMI on the power line	Check S6-8 Try alternate grounding or power source Add power conditioning

Remote Display Messages

10

INTRODUCTION

This section covers how the optional remote display is used with the Multi-Flame. The remote display provides LCD messages which monitor the status of the Multi-Flame's functions as well as any lockout conditions. This section is divided into two parts or tables:

- The first table describes the start-up and shutdown monitoring sequences of the Multi-Flame and how the progress (or halt) of the sequence can be monitored by the messages on the remote display.
- The second table alphabetically lists and explains the diagnostic messages which can appear on the remote display.



Note:

Some of the messages which may appear with some of the options are not shown; refer to Section 5, Function Summary, for details.

Table 10.1 Multi-Flame Operating Sequence

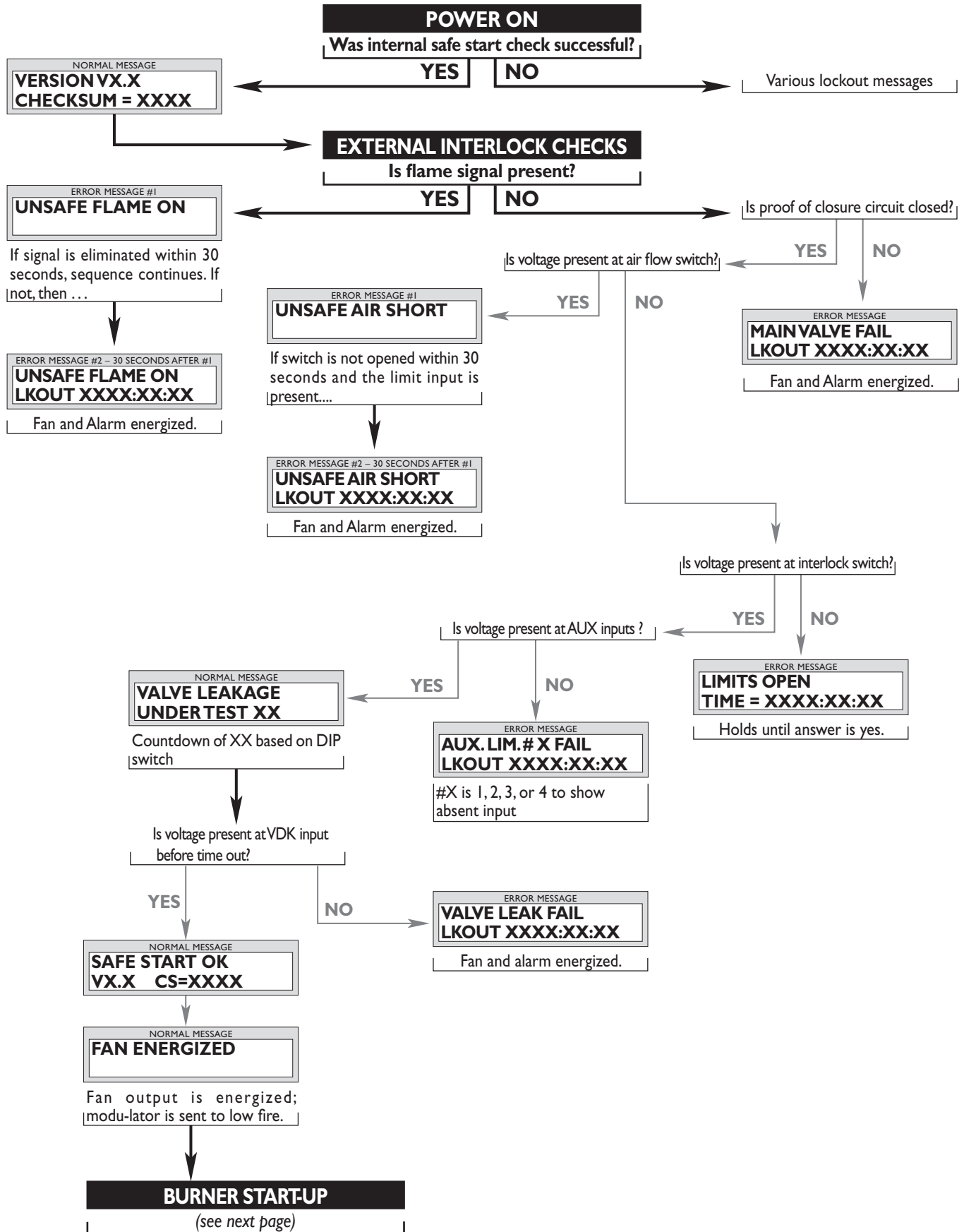
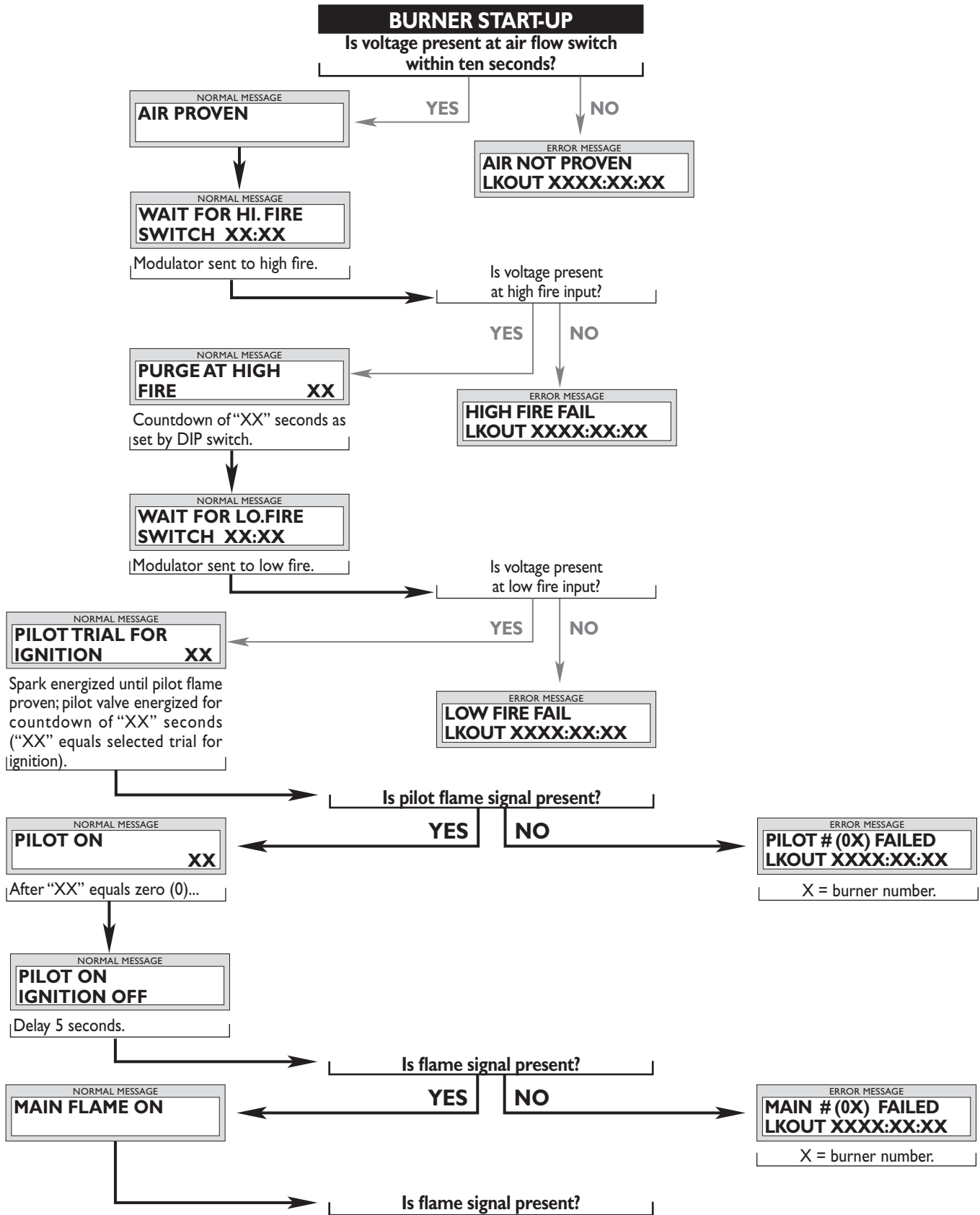

Table 10.1 Multi-Flame Operating Sequence (continued)



(see next page)

Table 10.1 Multi-Flame Operating Sequence (continued)

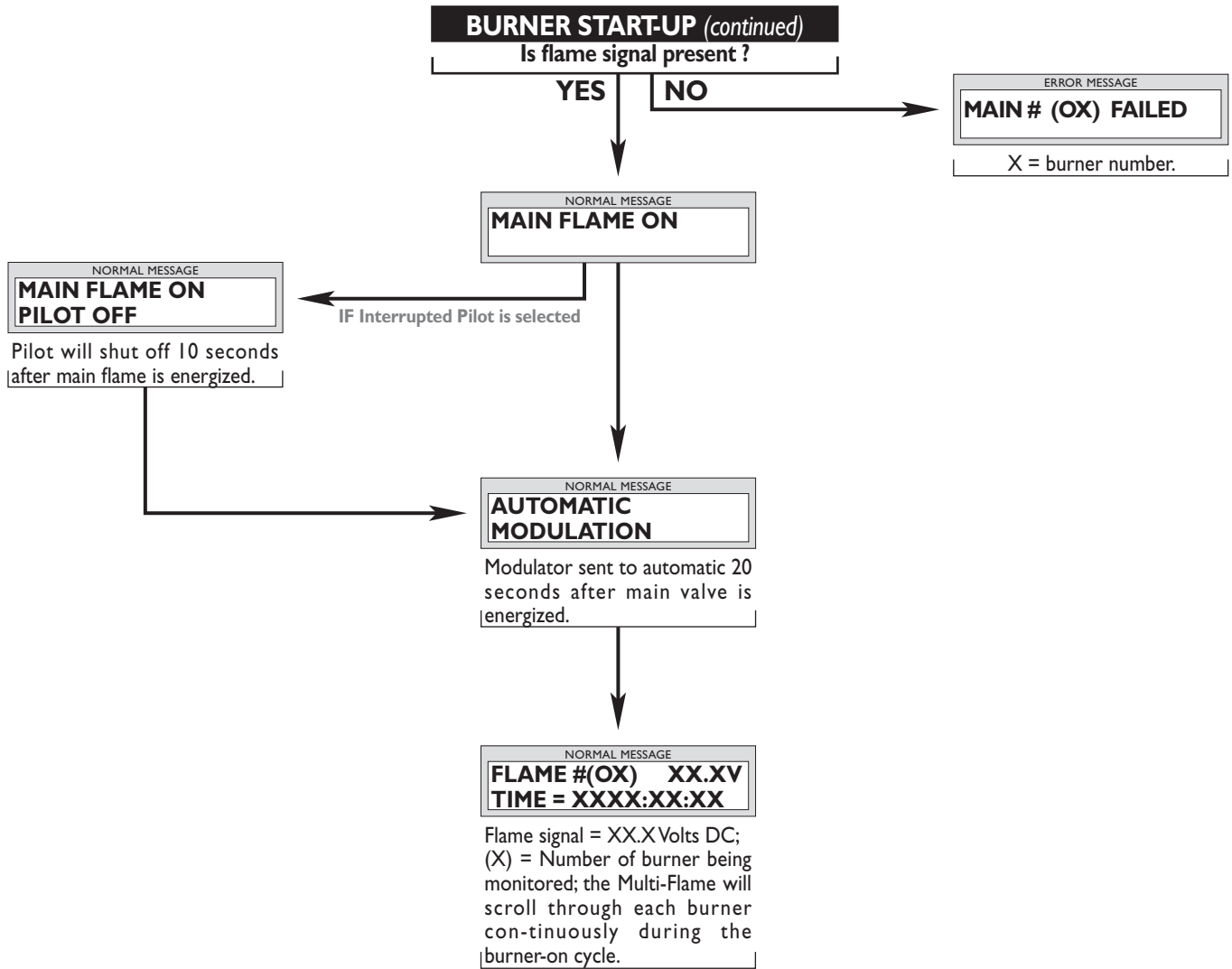

Table 10.1 Multi-Flame Operating Sequence (continued)

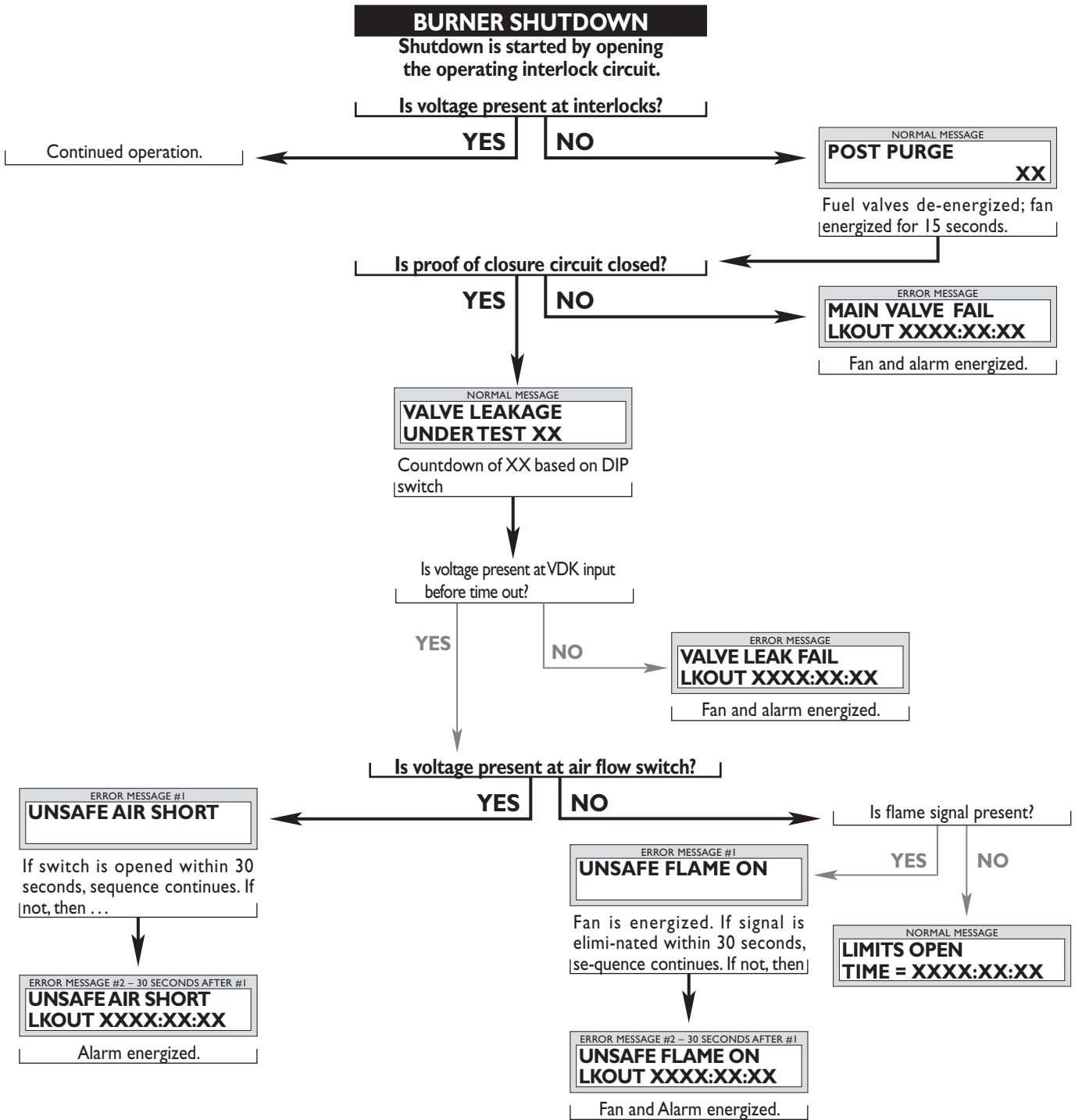

Table 10.2 Remote Display Diagnostic Messages (Listed Alphabetically)

MESSAGE	TYPE	EXPLANATION
AIR FAILURE LKOUT XXXX:XX:XX	Lockout	Combustion air flow limit switch (strip J1, terminal 2) opened for more than two seconds once initially proven.
AIR FAILURE RECYCLING	Status	Combustion air flow limit switch (strip J1, terminal 2) opened; control will recycle once if “recycle DIP switch has
AIR NOT PROVEN LKOUT XXXX:XX:XX	Lockout	Combustion air flow limit switch (strip J1, terminal 2) closed within ten seconds of fan being energized.
AIR PROVEN	Status	Modulating motor is sent to automatic operation. Terminal 1 is connected to terminal 2 on terminal strip J3
AUTOMATIC MODULATION	Status	Modulating motor is sent to automatic operation. Terminal 1 is connected to terminal 2 on terminal strip J3
AUX.LIM.#1 FAIL LKOUT XXXX:XX:XX	Lockout	Auxiliary input #1 has lost its voltage during system operation, causing a lockout at the indicated time.
AUX.LIM.#2 FAIL LKOUT XXXX:XX:XX	Lockout	Auxiliary input #2 has lost its voltage during system operation, causing a lockout at the indicated time.
AUX.LIM.#3 FAIL LKOUT XXXX:XX:XX	Lockout	Auxiliary input #3 has lost its voltage during system operation causing a lockout at the indicated time.
AUX.LIM.#4 FAIL LKOUT XXXX:XX:XX	Lockout	Auxiliary input #4 has lost its voltage during system operation causing a lockout at the indicated time.
CLOCK FAIL LKOUT XXXX:XX:XX	Lockout	The power line frequency comparison to the microprocessor clock crystal is out of tolerance.
FAN ENERGIZED	Status	Blower motor (strip J2, terminal 3) is energized at the start of pre-purge
FLAME # () FAIL RECYCLING	Status	Main flame lost during automatic modulation; control will recycle once if “recycle” has been selected.
FLAME # (X) FAIL LKOUT XXXX:XX:XX	Lockout	Main flame lost during operation in the automatic modulation mode. Burner number (X) given of failed unit.
FLAME #(Y) XX.XV TIME=XXXX:XX:XX	Status	Main flame of burner number (Y) is proven in the automatic modulation mode; flame strength is XX.XV (volts DC). Elapsed time is shown in hours:minutes:seconds
HI FIRE FAIL LKOUT XXXX:XX:XX	Lockout	High damper or high purge rate switch did not make and hold for high pre-purge.
INTERNAL FAULT LKOUT XXXX:XX:XX	Lockout	Internal control failure; replace controller
LIMITS OPEN TIME=XXXX:XX:XX	Status	The controller has completed its internal checks and is standing by for the interlocks (strip J1, terminal 1) to close.
LOW FIRE FAIL LKOUT XXXX:XX:XX	Lockout	Low fire switch (strip J1, terminal 4) is open just prior to pilot trial for ignition.

Table 10.2 Remote Display Diagnostic Messages (continued)

MESSAGE	TYPE	EXPLANATION
MAIN #() FAILED LKOUT XXXX:XX:XX	Lockout	Main flame was not established during the main burner trial for ignition.
MAIN FLAME ON	Status	Main valve has been energized and main flame proven during trial for ignition
MAIN FLAME ON PILOT OFF	Status	Pilot valve (strip J2, terminal 5) is de-energized and main flame is on
MAIN VALVE FAIL LKOUT XXXX:XX:XX	Lockout	Main valve proof-of-closure is open before startup or after burner shutdown.
PILOT FLAME FAIL LKOUT XXXX:XX:XX	Lockout	Pilot flame was not established during the pilot trial for ignition.
PILOT ON XX	Status	Pilot flame is proven; transformer is de-energized; remaining countdown for pilot trial for ignition is "XX".
PILOT TRIAL FOR IGNITION XX	Status	Pilot valve and ignition transformer are energized; countdown for pilot trial for ignition begins at "XX".
PLT/MVL ENERGIZ. XX:XX:XX LOCKOUT	Lockout	An external source of voltage is present on the ignition, pilot, or main output terminals.
POST PURGE XX	Status	15-second post purge is started on burner shutdown; "XX" shows countdown.
PROGM SWITCH ERR LKOUT XXXX:XX:XX	Lockout	DIP switch improperly set or changed during cycle.
PURGE AT HIGH FIRE XX	Status	Modulating motor is sent to high fire; "XX" whos purge count-down.
RECORD #X	Status	Part of the optional history log which records the total number of operating cycles and the last lockout messages up to a maximum of 10.
RELAY FAIL LKOUT XXXX:XX:XX	Lockout	Internal relay(s) fail initial check. Check ratings. If lockout still occurs after overload is eliminated, replace control.
SAFE START OK	Status	Control has completed internal self-check.
UNMATCH #XX OF XX LKOUT XXXX:XX:XX	Lockout	The number of Peek-A-Flame modules does not agree with the setting of DIP switch S6.
UNSAFE AIR SHORT	Status	Combustion air switch is closed before start-up or after shut-down; control holds start-up until switch re-opens; if interlocks close before switch opens, alarm will energize in 30 seconds.
UNSAFE AIR SHORT LKOUT XXXX:XX:XX	Lockout	Same conditions as above, except the interlocks closed for 30 seconds before the switch re-opened, causing a lockout and the alarm.

Table 10.2 Remote Display Diagnostic Messages (continued)

MESSAGE	TYPE	EXPLANATION
UNSAFE FLAME ON	Hold	Flame signal—actual, induced, or faulty scanner—is detected before startup or after shutdown. The fan is energized. If the cause is corrected within 30 seconds, as in afterburn, the control will turn off the fan and continue the sequence.
UNSAFE FLAME ON LKOUT XXXX:XX:XX	Lockout	Same conditions as above, except the cause has not been corrected within 30 seconds, resulting in a lockout and alarm.
UNSAFE-FLM-PURGE	Hold	Flame signal—actual, induced, or faulty scanner—is detected during the selected purge time period. The fan is energized. If the cause is corrected within 30 seconds, as in afterburn, the control will turn off the fan and continue the sequence.
UNSAFE-FLM-PURGE LKOUT XXXX:XX:XX	Lockout	Same conditions as above, except the cause has not been corrected within 30 seconds, resulting in a lockout and alarm.
VALVE LEAKAGE UNDER TEST XX	Status	Same conditions as above, except the cause has not been corrected within 30 seconds, resulting in a lockout and alarm.
VALVE LEAK FAIL LKOUT XXXX:XX:XX	Lockout	Indicates that the optional valve leak sensing device has been activated and the test period “XX” has begun.
WAIT FOR HI. FIRE SWITCH XX:XX	Hold	Driving damper to low position and waiting for position switch to apply voltage to J1-5
WAIT FOR LO. FIRE SWITCH XX:XX	Hold	Driving damper to low position and waiting for position switch to apply voltage to J1-4
WATCHDOG FAIL LKOUT XXXX:XX:XX	Lockout	Internal control failure; replace controller.
XXXXXXXX XXXXXTESTXX	Status	In combination with other messages, shows the control is in the minimum pilot test mode.



Appendix

CONVERSION FACTORS

Metric to English.

FROM	To	MULTIPLY BY
cubic meter (m ³)	cubic foot (ft ³)	35.31
cubic meter/hour (m ³ /h)	cubic foot/hour (cfh)	35.31
degrees Celsius (°C)	degrees Fahrenheit (°F)	(°C × 1.8) + 32
kilogram (kg)	pound (lb)	2.205
kilowatt (kW)	Btu/hr	3414
meter (m)	foot (ft)	3.28
millibar (mbar)	inches water column ("wc)	0.401
millibar (mbar)	pounds/sq in (psi)	14.5 × 10 ⁻³
millimeter (mm)	inch (in)	3.94 × 10 ⁻²

Metric to Metric.

FROM	To	MULTIPLY BY
kiloPascals (kPa)	millibar (mbar)	10
meter (m)	millimeter (mm)	1000
millibar (mbar)	kiloPascals (kPa)	0.1
millimeter (mm)	meter (m)	0.001

English to Metric.

FROM	To	MULTIPLY BY
Btu/hr	kilowatt (kW)	0.293 × 10 ⁻³
cubic foot (ft ³)	cubic meter (m ³)	2.832 × 10 ⁻²
cubic foot/hour (cfh)	cubic meter/hour (m ³ /h)	2.832 × 10 ⁻²
degrees Fahrenheit (°F)	degrees Celsius (°C)	(°F - 32) ÷ 1.8
foot (ft)	meter (m)	0.3048
inches (in)	millimeter (mm)	25.4
inches water column ("wc)	millibar (mbar)	2.49
pound (lb)	kilogram (kg)	0.454
pounds/sq in (psi)	millibar (mbar)	68.95

PURGE TIME EXAMPLE

Suppose your application requires a 5-minute purge time. This can be done by setting the Multi-Flame for 300 seconds (as shown in method 1) or for 5 minutes (as shown in Method 2).

DIP Switch:		METHOD:			
		1	Sec.	2	Min.
S4	SW8	=ON		=OFF	
S2	SW8	=OFF	x4	=ON	
	SW7	=ON		=ON	
	SW6	=OFF	60	=OFF	4
	SW5	=ON		=ON	
	SW4	=OFF	15	=OFF	1
Total:		4x(60+15)= 300		4+1= 5	

ASCII TEXT STRING EXAMPLE

1	2	3	4	5	6	7	8	9	0	1	2	3	4	5	6	7	8	9	0	1	2	3	4	5	6	7	8	9	0	1	2	3	4	5	6	7	8	9	0	1																			
	V	E	R	S	I	O	N	V	1	.	8			C	H	E	C	K	S	U	M	=	2	6	C	C			E	L	A	P	S	E	D	T	I	M	E	=	0	0	0	0	:	0	0	:	0	0	:	0	5						
	L	I	M	I	T	S	O	P	E	N			T	I	M	E	=	0	0	0	0	:	0	0	:	1	0			E	L	A	P	S	E	D	T	I	M	E	=	0	0	0	0	:	0	0	:	0	0	:	1	0					
V	A	L	V	E		L	E	A	K	A	G	E			U	N	D	E	R		T	E	S	T			3	3			E	L	A	P	S	E	D	T	I	M	E	=	0	0	0	0	:	0	0	:	0	7							
	S	A	F	E		S	T	A	R	T	O	K			V	1	.	8			C	S	=	2	6	C	C			E	L	A	P	S	E	D	T	I	M	E	=	0	0	0	0	:	0	0	:	1	2								
F	A	N		E	N	E	R	G	I	Z	E	D																		E	L	A	P	S	E	D	T	I	M	E	=	0	0	0	0	:	0	0	:	1	3								
A	I	R		P	R	O	V	E	N																					E	L	A	P	S	E	D	T	I	M	E	=	0	0	0	0	:	0	0	:	1	7								
W	A	I		F	O	R	H	I	.	F	I	R	E	S	W	I	T	C	H												E	L	A	P	S	E	D	T	I	M	E	=	0	0	0	0	:	0	0	:	2	1							
P	U	R	G	E		A	T	H	I	G	H	.		F	I	R	E														0	:	0	6				E	L	A	P	S	E	D	T	I	M	E	=	0	0	0	0	:	0	0	:	3	4
W	A	I		F	O	R	L	O	.	F	I	R	E	S	W	I	T	C	H												E	L	A	P	S	E	D	T	I	M	E	=	0	0	0	0	:	0	0	:	3	0							
P	I	L	O	T		T	R	I	A	L		F	O	R		I	G	N	I	T	I	O	N									1	3				E	L	A	P	S	E	D	T	I	M	E	=	0	0	0	0	:	0	0	:	4	8	
P	I	L	O	T		O	N																								0	8				E	L	A	P	S	E	D	T	I	M	E	=	0	0	0	0	:	0	0	:	5	4		
P	I	L	O	T		O	N																														E	L	A	P	S	E	D	T	I	M	E	=	0	0	0	0	:	0	1	:	0	2	
M	A	I	N		F	L	A	M	E		O	N																									E	L	A	P	S	E	D	T	I	M	E	=	0	0	0	0	:	0	1	:	0	8	
A	U	T	O	M	A	T	I	C																													E	L	A	P	S	E	D	T	I	M	E	=	0	0	0	0	:	0	1	:	2	8	
F	L	A	M	E	#	(0	1)		0	9	.	7	V	T	I	M	E	=		0	0	0	0	:	0	2	:	0	5				E	L	A	P	S	E	D	T	I	M	E	=	0	0	0	0	:	0	2	:	0	5			
F	L	A	M	E	#	(0	2)		0	9	.	7	V	T	I	M	E	=		0	0	0	0	:	0	2	:	0	7				E	L	A	P	S	E	D	T	I	M	E	=	0	0	0	0	:	0	2	:	0	7			
F	L	A	M	E	#	(0	3)		0	9	.	7	V	T	I	M	E	=		0	0	0	0	:	0	2	:	0	9				E	L	A	P	S	E	D	T	I	M	E	=	0	0	0	0	:	0	2	:	0	9			
F	L	A	M	E	#	(0	4)		0	9	.	7	V	T	I	M	E	=		0	0	0	0	:	0	2	:	1	1				E	L	A	P	S	E	D	T	I	M	E	=	0	0	0	0	:	0	2	:	1	1			
P	O	S	T		P	U	R	G	E																												E	L	A	P	S	E	D	T	I	M	E	=	0	0	0	0	:	0	0	:	0	1	

TIMING SEQUENCE

	#	Function	Cycle Start, Leak Check	Air	Purge Timing	Low Fire Start	Trial for Ignition	Flame Check	Main On	Interrupted Pilot	Post Purge	Leak Check
J2 Outputs	2	Control Power	On									
	5	Pilot Valve	On						(= TFI s.)	Intermittent		
	6	Ignition	On									
	4	Main Valve	On					5 s.				
	3	Fan	On								15 s.	
	7	Leak Detect Out	On	40 or 110 seconds minimum on								
J1 Inputs	2	Air Switch	On	10 s.								
	1	Limit Interlock	On									
	3	POVC	On									
	4	Low Fire Switch	On									
	5	High Fire Switch	On									
	6	Leak Detect In	On	40 or 110 s.								40/110 s.
	7-10	Aux # 1 - 4	On									
J3 Mod Contact	1 - 4	Low Fire	On									
	1 - 3	High Purge	On									
	1 - 2	Automatic	On						20 s.			

ILLUSTRATED PARTS LIST

Pos. No.	Qty.	Part Name	Eclipse Part No.
1	1	Motherboard (6000M) with RS232	22493
1	1	Motherboard (6000M) with RS485	22493-1
-	1	Sub-assembly of Items 1,2,3,4 with RS232	22579
-	1	Sub-assembly of Items 1,2,3,4 with RS485	22579-1
2	1	Relay module (6000R)	22494
3	1	Logic Module (6000L)	22495
4	1	Power module (6000P)	22496
-	1	Cover for Logic, power, relay	22850
-	4	Screws, 6-32x3/8, for cover	22851
5	1 to 20	Peek-A-Flame (7000)	22497
7	1	Expansion board (for up to four burners)	15429
8	1 to 2	Expansion board (for up to eight burners)	101112
9	1	152 mm (6 in) cable for expansion board	15734
9	1	914 mm (3 ft) cable for expansion board	15734-1
10	1	183 cm (6 ft) cable for remote display	15426
10	1	305 cm (10 ft) cable for remote display	15426-1
11	1	Remote display with keypad	15422

To make sure that the downtime of the system is as short as possible in case of a failure, you should keep a stock of spare parts.



Note:

The four burner expansion board **CANNOT** be used in conjunction with the eight burner expansion board.

